

UPT-640 [®]

Operating Instructions



The UPT-640 temperature controller is a key component in an ULTRA-PULSE system, because it is responsible for all heat management functions, i.e. controlling the temperature of the heating element and ensuring that this highly dynamic impulse heatsealing method is accurately timed.

Important features

- Microprocessor technology
- LC display (green), 4 lines, 20 characters, (multilingual)
Alternatively:
VF display (blue), 4 lines, 20 characters, (multilingual)
- Automatic zero calibration (AUTOCAL)
- Booster connection as standard
- Heatsealing band alloy and temperature range selectable
- Time control, heatsealing time and cooling time settable
- Externally or internally generated release impulse with programmable parameters
- Configurable relay output, e.g. "end of cycle"
- Time or temperature-controlled cooling phase
- Signal output for "Temperature OK"
- 0...10VDC analog input for set point selection, electrically isolated
- 0...10VDC analog output for ACTUAL temperature, electrically isolated
- 24VDC control inputs for AUTOCAL, PREHEAT and RESET, electrically isolated
- Alarm function with fault diagnosis
- Cooling system monitored

Contents

1	Safety and warning notes	3	9	Controller functions	21
1.1	Use	3	9.1	Indicators and controls	21
1.2	Heating element	3	9.2	Display	21
1.3	Impulse transformer	3	9.3	Navigation in the menus	23
1.4	Current transformer PEX-W2	3	9.4	Menu structure	26
1.5	Line filter	3	9.5	Menu steps	28
1.6	Warranty provisions	3	9.6	Temperature setting (set point selection)	34
1.7	Standards / CE marking	4	9.7	Temperature indication/actual value output	35
2	Application	4	9.8	Automatic zero calibration (AUTOCAL)	36
3	System description	5	9.9	"START" signal (HEAT)	37
3.1	Temperature controller	5	9.10	"RESET" signal	38
3.2	Current transformer	6	9.11	"Temperature OK" signal	38
3.3	Booster	6	9.12	Cycle counter	39
4	Accessories and Modifications	6	9.13	Hold mode	39
4.1	Accessories	6	9.14	Time control (timer function)	40
4.2	Modifications (MODs)	8	9.15	Release impulse	43
5	Technical data	9	9.16	Correction factor Co	46
6	Dimensions/front panel cutout	11	9.17	Manual impulse	46
7	Installation	12	9.18	Maximum starting temperature	47
7.1	Installation steps	12	9.19	Disabling the Configuration menu	47
7.2	Installation procedure	12	9.20	Setting the display brightness (VF display only)	48
7.3	Power supply	13	9.21	Undervoltage detection	48
7.4	Line filter	14	9.22	Booster connection	48
7.5	Current transformer PEX-W2	14	9.23	System monitoring/alarm output	48
7.6	Wiring diagram (standard)	15	9.24	Error messages	49
7.7	Wiring diagram with booster connection	16	9.25	Fault areas and causes	51
8	Startup and operation	17	10	Factory settings	52
8.1	Front view of the controller	17	11	Maintenance	53
8.2	Rear view of the controller	17	12	How to order	54
8.3	Controller configuration	17	13	Index	55
8.4	Startup procedure	19			

1 Safety and warning notes

This CIRUS temperature controller is manufactured according to DIN EN 61010-1. In the course of its manufacture it passed through quality assurance, whereby it was subjected to extensive inspections and tests.

It left the factory in perfect condition.

The recommendations and warning notes contained in these operating instructions must be complied with, in order to guarantee safe operation.

The device can be operated within the limits indicated in the "Technical Data" without impairing its operational safety. Installation and maintenance may only be performed by technically trained, skilled persons who are familiar with the associated risks and warranty provisions.

1.1 Use

CIRUS temperature controllers may only be used for heating and temperature control of heatsealing elements which are expressly suitable for them, and providing the regulations, notes and warnings contained in these instructions are complied with.

 **In case of non-compliance or use contrary to the intended purpose, there is a risk that safety will be impaired or that the heatsealing element, electrical wiring, transformer etc. will overheat. Ensuring such compliance is the personal responsibility of the user.**

1.2 Heating element

The temperature coefficient of a CIRUS temperature controller is specially adapted to CIRUS heating elements.

 **The controller is not allowed to be operated with any other heatsealing bands because they could be overheated and damaged beyond repair.**

1.3 Impulse transformer

A suitable impulse transformer is necessary to ensure that the control loop functions perfectly. This transformer must be designed according to VDE 0570/EN 61558 (isolating transformer with reinforced

insulation) and have a one section bobbin. When the impulse transformer is installed, suitable shock protection must be provided in accordance with the national installation regulations for electrical equipment. In addition, water, cleaning solutions and conductive fluids must be prevented from seeping into the transformer.

 **Incorrect installation of the impulse transformer impairs electrical safety.**

1.4 Current transformer PEX-W2

The current transformer supplied with the CIRUS temperature controller is an integral part of the control system.

 **Only the original ROPEX PEX-W2 current transformer may be used. Other transformers may cause the equipment to malfunction.**

The current transformer may only be operated if it is connected to the CIRUS temperature controller correctly (see section 9, "Startup and operation"). The relevant safety instructions contained in section 8.3, "Power supply", must be obeyed. External monitoring modules can be used in order to additionally increase operating safety. They are not included in the scope of supply of the standard control system and are described in a separate document.

1.5 Line filter

The use of an original ROPEX line filter is mandatory in order to comply with the standards and provisions mentioned in section 1.7 "Standards / CE marking" on page 4. This device must be installed and connected according to the instructions contained in section 8.3, "Power supply" as well as the separate documentation enclosed with the line filter.

1.6 Warranty provisions

The statutory provisions for warranties apply for a period of 12 months following the delivery date. All devices are tested and calibrated in the factory. Devices that have been damaged due to faulty connections, dropping, electrical overloading, natural

wear, incorrect or negligent handling, chemical influences or mechanical overloading as well as devices that have been modified, relabeled or otherwise altered by the customer, for example in an attempt to repair them or install additional components, are excluded from the warranty. Warranty claims must be examined in the factory and approved by ROPEX.

1.7 Standards / CE marking

The controller described here complies with the following standards, provisions and directives:

- DIN EN 61010-1 (VDE 0411-1) Safety provisions for electrical measuring, control and laboratory devices (low voltage directive).
Overvoltage category III, pollution severity 2, safety class II.
- DIN EN 60204-1 Electrical equipment of machines (machinery directive)
- EN 50081-1 EMC interference emissions according to EN 55011, group 1, class B
- EN 50082-2 EMC interference immunity: ESDs, RF radiation, bursts, surges.

Compliance with these standards and provisions is only guaranteed if original accessories and/or peripheral components approved by ROPEX are used. If not, then the equipment is operated on the user's own responsibility.

The CE marking on the controller confirms that the device itself complies with the above-mentioned standards.

It does not imply, however, that the overall system also fulfils these standards.

It is the responsibility of the machine manufacturer and of the user to verify the completely installed, wired and operationally ready system in the machine with regard to its conformity with the safety provisions and the EMC directive (see also section 8.3, "Power supply"). If peripheral components (e.g. the transformer or the line filter) from other manufacturers are used, no functional guarantee can be provided by ROPEX.

2 Application

This CIRUS temperature controller is an integral part of the "series 600". Its sole purpose is to control the temperature of CIRUS/UPT heating elements, which are used mainly for impulse-heatsealing PP and PE films.

The most important applications are packaging machines, pouch-making machines, splicers, machines for making pharmaceutical and medical products etc.

3 System description

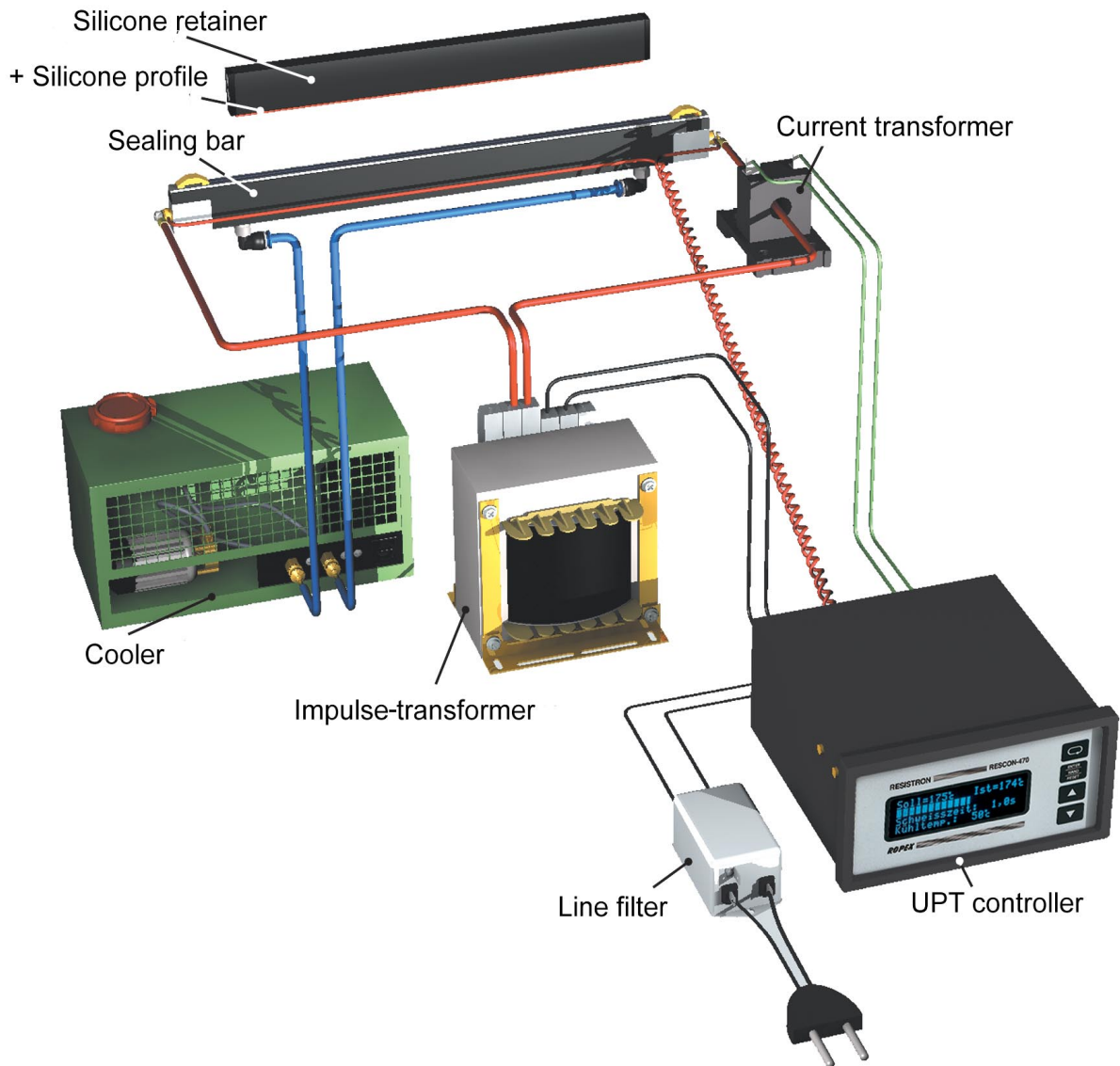

The basic design of the overall system is shown in the diagram above.

CIRUS heating elements, and in particular UPT heating elements, are high-performance systems which operate efficiently and reliably providing all the components in the control loop are optimally tuned to one another – and to the task at hand. Exact compliance with the installation and wiring instructions is essential. The system has been evolved and optimized by ROPEX GmbH in an intensive development process. Users who follow our technical recommendations will profit from the unique functionality of this technology, which reduces the customer's effort for installation, commissioning and maintenance to a minimum.

3.1 Temperature controller

The controller calculates the resistance of the heating element by measuring the current and voltage at a high sampling rate (= line frequency), compares it with the set point and – if the difference is not 0 – adjusts the heating current with the help of a phase angle-controlled transformer so that set = actual.

The fact that purely electrical variables are measured in quick succession and the small mass of the heating

layer of the UPT heating element together result in a highly dynamic, thermo-electrical control loop.

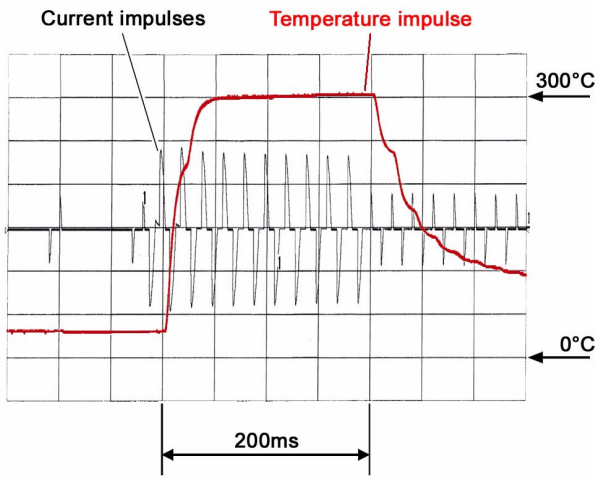

Thanks to its microprocessor based technology, the controller features an optimized control algorithm as well as numerous functions tailored to the various tasks, such as "AUTOCAL", TIMER functions, RELEASE IMPULSE, ALARM with fault diagnosis etc. These are described in detail below.

An easy-to-read, 4-line, multilingual display visualizes all parameters, measured values and states. The con-

troller can also interact with external controllers (PLC, IPC etc.) via the analog INPUTS and OUTPUTS.

The UPT-640 controller is designed for installation in a front panel cutout, but can also be accommodated in the electrical cabinet using an adapter for top hat rail mounting (↪ "Adapter for top hat rail mounting (HS-Adapter-01)" on page 7).

3.2 Current transformer

The PEX-W2 current transformer supplied with the CIRUS UPT-640 controller is an integral part of the control system. Only this original ROPEX current transformer is allowed to be used.

Never attempt to operate the current transformer with open connections!

3.3 Booster

If the maximum load exceeds the rated current of the controller (↪ section 5 "Technical data" on page 9), an external switching amplifier (booster) must be used (↪ section 4.1 "Accessories" on page 6).

The other system components – UPT sealing bars, transformers, filter, cooler etc. – are described in separate brochures.







4 Accessories and Modifications

A wide range of harmonized accessory components and peripheral devices are available for the CIRUS temperature controller UPT-640. They allow it to be optimally adapted to your specific heatsealing application and to your plant's design and operating philosophy.

4.1 Accessories

The products described below are only a few of the wide range of accessories available for CIRUS temperature controller (↪ "Accessories" leaflet).

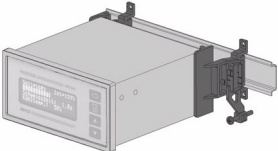
	<p>Analog temperature meter ATR-3 For front panel mounting or mounting on a top hat rail. Analog indication of the ACTUAL temperature of the heatsealing band in °C. The meter damping of the unit is optimized for the abrupt temperature changes that occur in impulse mode.</p>
	<p>Digital temperature meter DTR-x For front panel mounting or mounting on a top hat rail. Digital indication of the ACTUAL temperature of the heatsealing band in °C, with HOLD function.</p>

	<p>Line filter LF-xx480 Essential in order to ensure CE conformity. Optimized for the CIRUS temperature controller.</p>
	<p>Impulse transformer ITR Designed according to VDE 0570/EN 61558 with a one-section bobbin. Optimized for impulse operation with CIRUS temperature controllers. Dimensioned according to the heatsealing application (↪ ROPEX Application Report).</p>
	<p>Booster B-xxx400 External switching amplifier, necessary for high primary currents (continuous current > 5A, pulsed current > 25A).</p>
	<p>Set point potentiometer PD-3 Front panel mounting version for setting the required SET heatsealing temperature of the CIRUS temperature controller. The number which appears on the display corresponds to the SET heatsealing temperature in °C.</p>
	<p>Transparent front cover TFA-1 For increasing the degree of protection on the front of the controller to IP65. Also facilitates applications in the food technology sector (GMP).</p>
	<p>Adapter for top hat rail mounting (HS-Adapter-01) For mounting the CIRUS temperature controller UPT-640 on a top hat rail (DIN TS35). Allows the controller to be installed in the electrical cabinet, for instance, where it is only accessible to authorized persons.</p>
	<p>Lockable door TUER-S/K-1 Transparent door (with lock) for mounting on the bezel of the controller. The display is clearly legible at all times. The keyboard can only be operated, however, by authorized persons in possession of a key.</p>
	<p>Measurement cable UML-1 Twisted measurement cable for the U_R-voltage measurement. Trailing cable, halogen and silicone free.</p>

4.2 Modifications (MODs)

No modifications are necessary owing to the extensive functionality of the UPT-640 controller.

5 Technical data

Type of construction	Housing for front panel mounting Dimensions (W x H): 144 x 72mm; depth: 161 mm (incl. terminals)
Line voltage	<u>All controllers manufactured as of January 2004:</u> 230VAC version: 230VAC -15%...240VAC +10% (equivalent to 196...264VAC) 400VAC version: 400VAC -15%...415VAC +10% (equivalent to 340...456VAC) <u>All controllers manufactured up to December 2003:</u> 230VAC or 400VAC, tolerance: +10% / -15% depending on device version (↪ section 12 "How to order" on page 54)
Line frequency	47...63Hz, automatic adjustment to frequencies in this range
Type of heating element and temperature range	Two different ranges can be set on the controller in the Configuration menu: Temperature coefficient 1700ppm (adapted to the ULTRA-PULSE heating elements): 40...200°C, 40...300°C
Set point selection/ analog input Terminals 20+23	Via the Settings menu in the controller or the electrically isolated analog input: Input resistance: 40kohms, reverse polarity-protected 0...10VDC, equivalent to 0...300°C
Analog output (actual value) Terminals 20+24	0...10VDC, I _{max} = 5mA Equivalent to 0...300°C Electrically isolated
Digital logic levels Terminals 3, 4, 22, 25, 26	LOW (0V): 0...2VDC HIGH (24VDC): 12...30VDC (max. current input 6mA) Electrically isolated, reverse polarity-protected
START with contact Terminals 2+7	Switching threshold: 3.5VDC, U _{max} = 5VDC, I _{max} = 5mA
Switching output for "Temp. OK" signal Terminals 20+21	U _{max} = 30VDC, I _{max} = 50mA U _{ON} < 2V (saturation voltage) Transistor conductive if the temperature is inside the tolerance band.
Alarm relay Terminals 5+6	Contact, potential-free, U _{max} = 50VDC, I _{max} = 0.2A
Relay K1 Terminals 16, 17, 18	Changeover contact, potential-free, U _{max} = 240VAC/100VDC, I _{max} = 1.5A Interference suppression with 47nF / 560ohms for each terminal
Maximum load (primary current of impulse transformer)	I _{max} = 5A (duty cycle = 100%) I _{max} = 25A (duty cycle = 20%)
Display	LC display (green), 4 lines, 20 characters, alternatively: VF display (blue), 4 lines, 20 characters
Ambient temperature	+5...+45°C
Degree of protection	Front: IP42 (IP65 with transparent front cover TFA-1, Art No. 887000) Back: IP20

Installation	Installed in front panel cutout with (W x H) $138^{(+0.2)} \times 68^{(+0.2)}$ mm Fastened with clips.
Weight	Approx. 1.0kg (incl. connector plug-in parts)
Housing material	Black plastic, type Noryl SE1 GFN2
Connecting cable Type / cross-sections	Rigid or flexible; $0.2 \dots 2.5 \text{ mm}^2$ (AWG 24...12) Plug-in connectors

6 Dimensions/front panel cutout

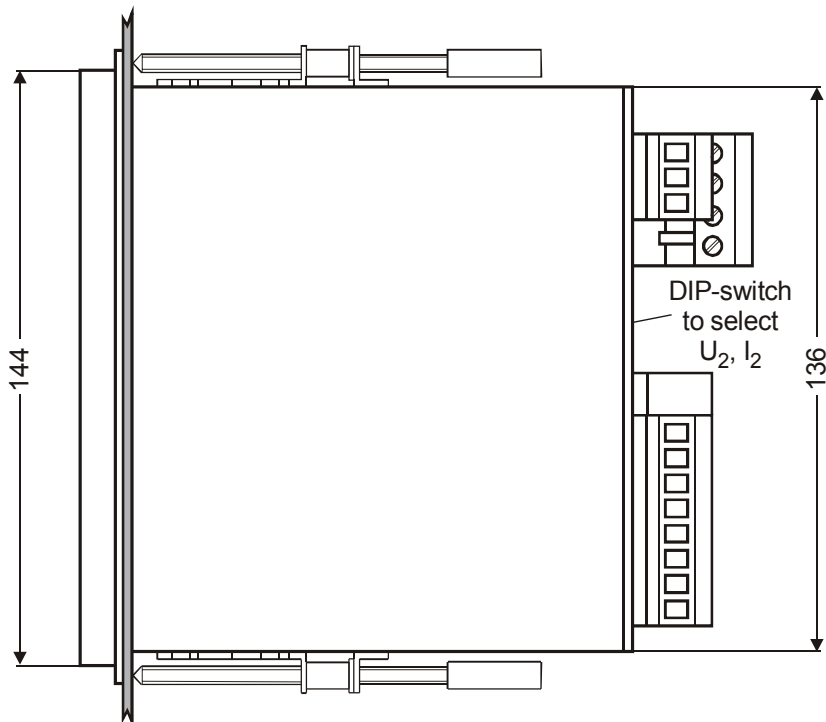
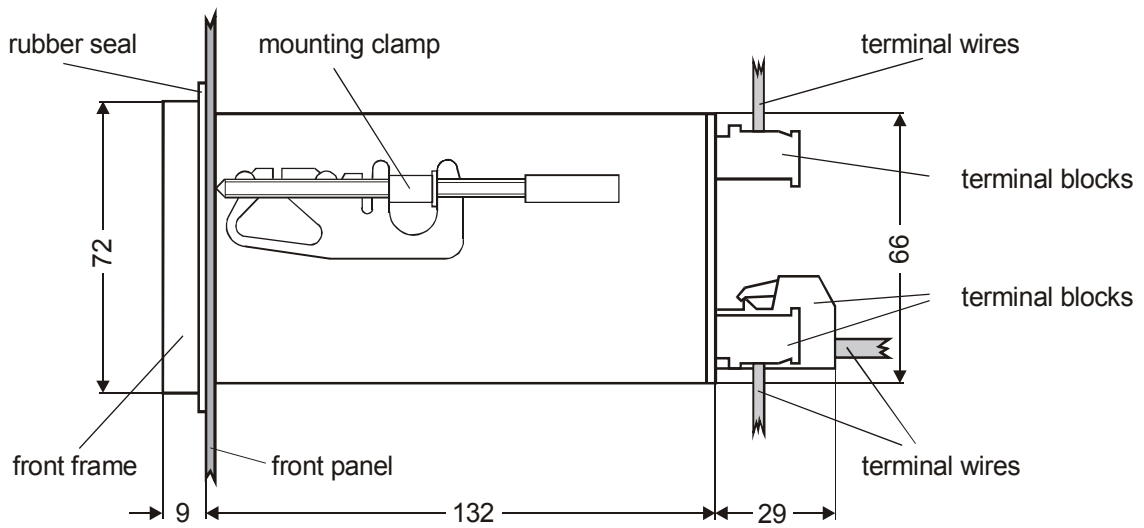
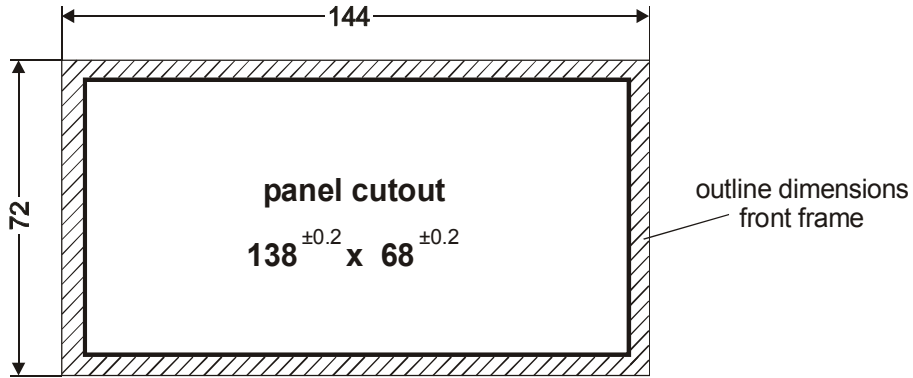

7 Installation

↪ See also section 1 "Safety and warning notes" on page 3.

 **Installation and startup may only be performed by technically trained, skilled persons who are familiar with the associated risks and warranty provisions.**

7.1 Installation steps

1. Please refer to the safety and warning notes (↪ section 1 "Safety and warning notes" on page 3).
2. The information provided in the customized ROPEX Application Report, which is prepared by ROPEX specifically for each application, should be heeded at all times.
3. All electrical components, such as the controller, the impulse transformer and the line filter, should be installed as close as possible to the UPT sealing bar(s) in order to avoid long wires.
4. Connect the voltage measurement cable U_R directly to the UPT sealing bar and lay it twisted to the controller (UML-1 voltage measurement cable ↪ section 4 "Accessories and Modifications" on page 6).
5. Ensure an adequate cable cross-section for the primary and secondary circuits (↪ Application Report).
6. Use only ROPEX impulse transformers or transformers approved by ROPEX. Please note the power,

the duty cycle and the primary and secondary voltages (↪ Application Report).

7.2 Installation procedure

Proceed as follows to install the CIRUS temperature controller UPT-640:

1. Switch off the line voltage and verify the safe isolation from the supply.
2. The supply voltage specified on the nameplate of the CIRUS temperature controller must be identical to the line voltage that is present in the plant or machine. The line frequency is automatically detected by the temperature controller in the range from 47Hz to 63Hz.
3. Install the CIRUS temperature controller in the front panel cutout. It is fastened by means of two clips which snap onto the side of the controller housing.
4. Wire the system in accordance with the instructions in section 7.3 "Power supply" on page 13, section 7.6 "Wiring diagram (standard)" on page 15 and the ROPEX Application Report. The information provided in section 7.1 "Installation steps" on page 12 must be heeded additionally.

 **Check the tightness of all the system connections, including the terminals for the winding wires on the impulse transformer.**

5. Make sure that the wiring conforms to the relevant national and international installation regulations.

7.3 Power supply

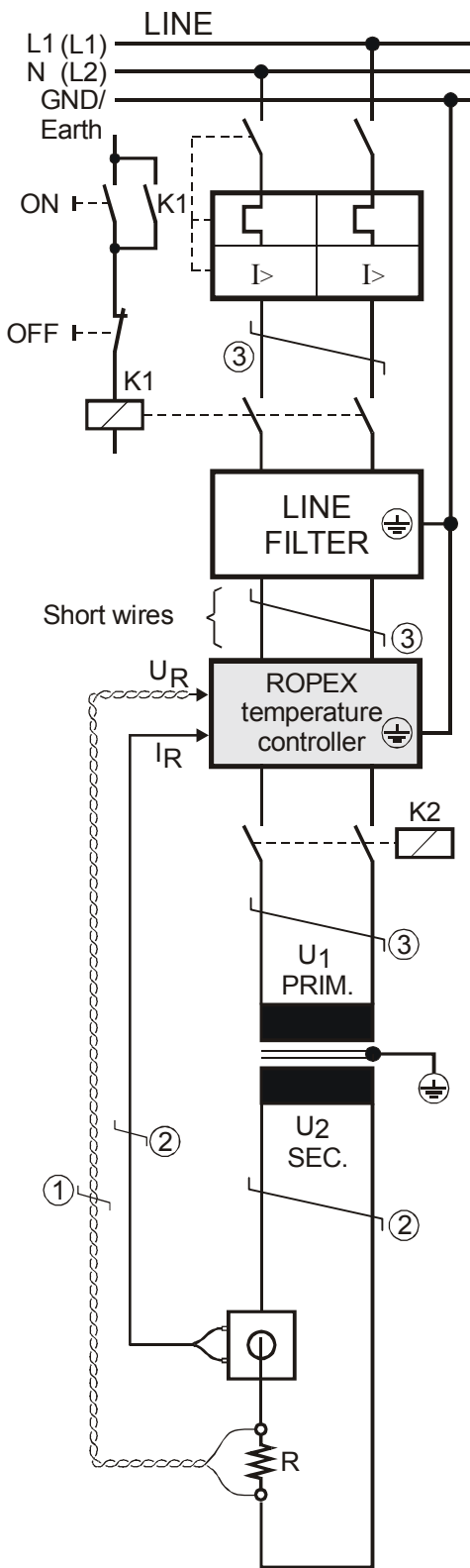

Line

115VAC, 230VAC, 400VAC
+10% / -15%, 50/60Hz

Circuit breaker

Double-pole, Z characteristic
Rated current: 16A, e.g. ABB-STOTZ, Type S282-Z16 (for all applications)

! Short-circuit protection only.
! CIRUS temperature controller not protected.

Relay K1

For "HEAT ON - OFF" function (all-pole) or "EMERGENCY STOP".

Line filter

The filter type and size must be determined according to the load, the transformer and the machine wiring (↪ ROPEX Application Report).

! Do not run the filter supply wires (line side) parallel to the filter output wires (load side).

CIRUS temperature controller belonging to the 6xx Series.

Relay K2

Load break (all-pole), e.g. in combination with the alarm output of the temperature controller.

Impulse Transformer

Designed according to VDE 0570/EN 61558 (isolating transformer with reinforced insulation). Connect core to ground.

! Use transformers with a one section bobbin. The power, duty cycle and voltage values must be determined individually according to the application (↪ ROPEX Application Report and "Accessories" leaflet for impulse transformers).

Wiring

The wire cross-sections depend on the application (↪ ROPEX Application Report).

Guide values:

- Primary circuit: min. 1.5mm², max. 2.5mm²
- Secondary circuit: min. 4.0mm², max. 25mm²

- ① These wires must always be twisted (>20/m)
- ② These wires must be twisted (>20/m) if several control loops are laid together ("crosstalk").
- ③ Twisting (>20/m) is recommended to improve EMC.

7.4 Line filter

To comply with EMC directives – corresponding to EN 50081-1 and EN 50082-2 – RESISTRON control loops must be operated with line filters.

These filters damp the reaction of the phase-angle control on the line and protect the controller against line disturbances.

! The use of a suitable line filter is part of the standards conformity and a prerequisite of the CE mark.

installed and wired correctly, they guarantee compliance with the EMC limit values.

You can find the exact specification of the line filter in the ROPEX Application Report calculated for your particular heatsealing application.

For more technical information: ↪ "Line filter" documentation.

! It is permissible to supply several CIRUS control loops with a single line filter, providing the total current does not exceed the maximum current of the filter.

ROPEX line filters are specially optimized for use in RESISTRON control loops. Providing that they are

The wiring instructions contained in section 7.3 "Power supply" on page 13 must be observed.

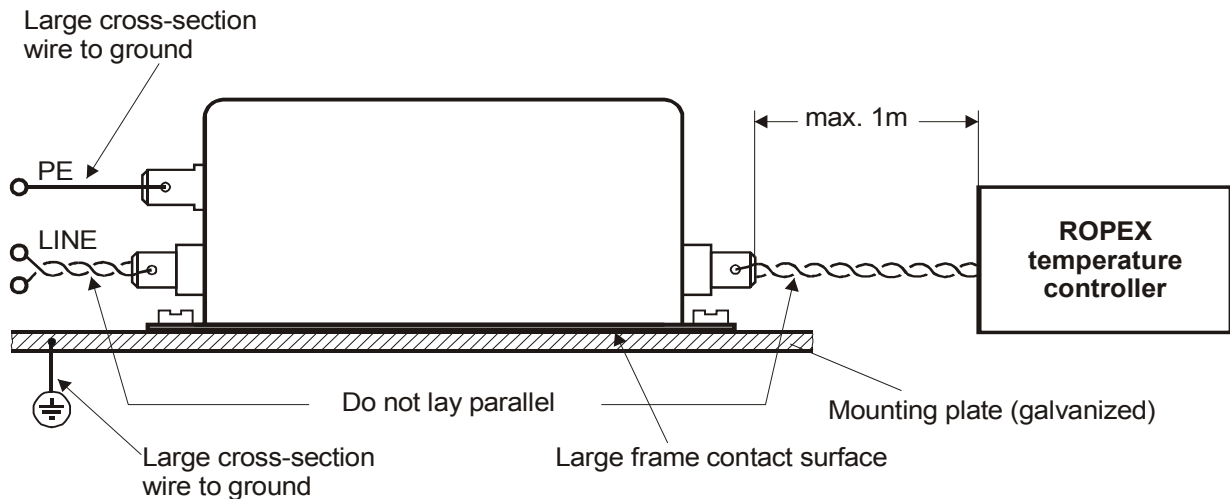

7.5 Current transformer PEX-W2

The PEX-W2 current transformer supplied with the RESISTRON temperature controller is an integral part

of the control system. The current transformer may only be operated if it is connected to the temperature controller correctly (↪ section 7.3 "Power supply" on page 13).

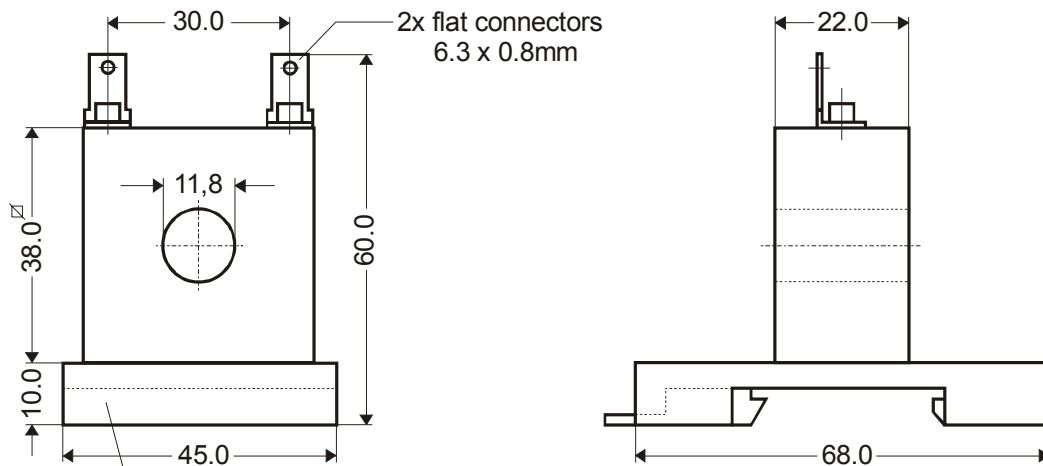

Snap-on plate for top hat rail (DIN TS35 rail), 35 x 7.5mm or 35 x 15mm, acc. DIN EN 50022

7.6 Wiring diagram (standard)

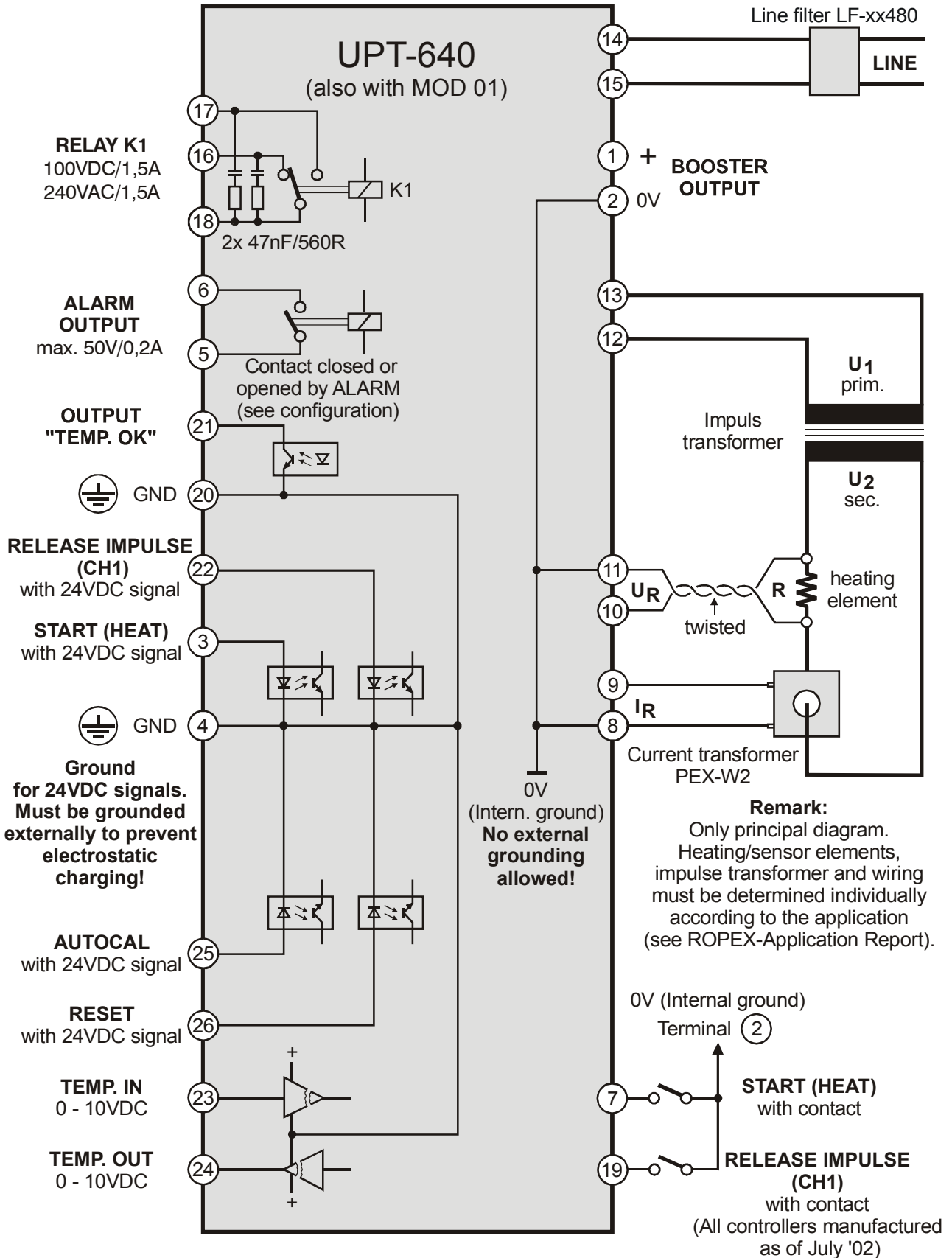

7.7 Wiring diagram with booster connection

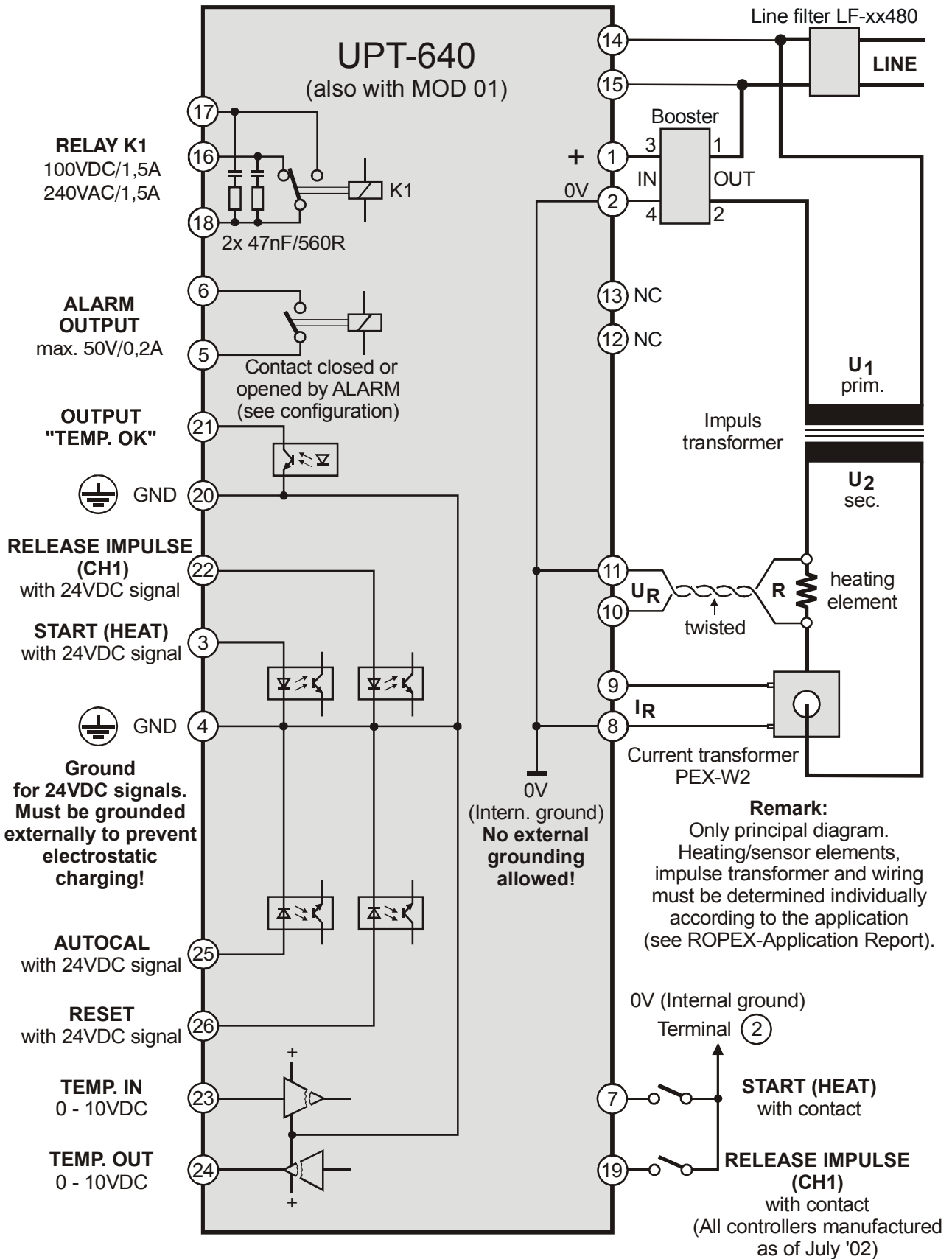

8 Startup and operation

8.1 Front view of the controller



8.2 Rear view of the controller

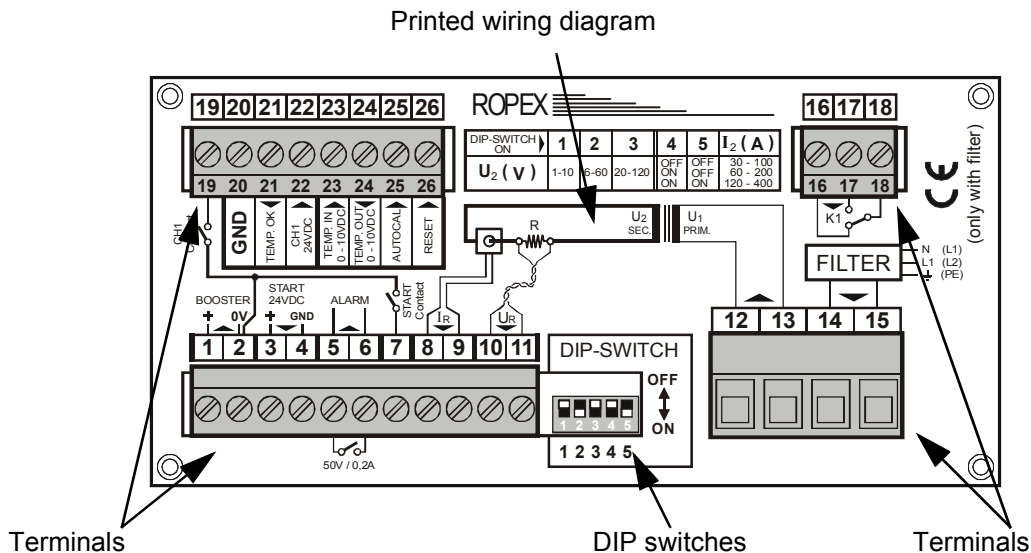

8.3 Controller configuration

The possible controller configurations are explained in the following sections. Proceed as described in section 7.2 "Installation procedure" on page 12 to start up the controller for the first time.

8.3.1 Configuration of the DIP switches for secondary voltage and current



The controller must be switched off in order to configure the DIP switches.

Set the DIP switches for matching the secondary voltage U_2 and the secondary current I_2 to the correct position for **your** application.

! You can find the exact configuration of the DIP switches in the ROPEX Application Report calculated for your particular application.

Rear view of the controller

U_2 ↓	DIP switch			I_2 ↓	DIP switch	
	1	2	3		4	5
1...10V	ON	OFF	OFF	30...100A	OFF	OFF
6...60V	OFF	ON	OFF	60...200A	ON	OFF
20...120V	OFF	OFF	ON	120...400A	ON	ON

If the secondary current I_2 is less than 30A, the PEX-W2 current transformer must have two turns (↪ ROPEX Application Report).

! If the controller settings are unknown when it is started up for the first time, the factory settings must be restored in order to prevent malfunctions.



8.3.4 Configuration of the alloy and the temperature range

These parameters are set with step 32 in the Configuration menu:

8.3.2 Setting the language

The menu language can be changed on the controller without interrupting operation. It is set with step 30 in the Configuration menu:

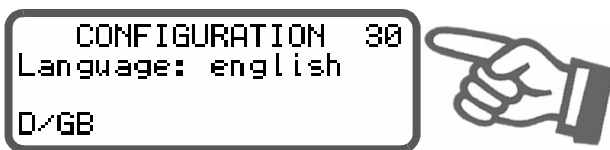
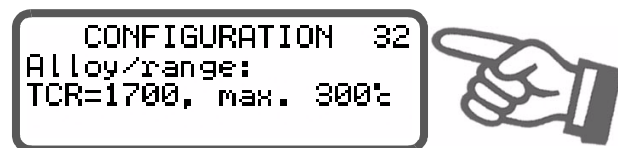

Two different ranges can be selected:

1. Temperature coefficient 1700ppm, 0...200°C
2. Temperature coefficient 1700ppm, 0...300°C (•)

! The language which is selected in this menu remains set even if the factory settings are restored (step 31 in the Configuration menu).

8.3.5 Configuration of the timer function

8.3.3 Restoring the factory settings

The internal controller settings can be reset to the factory settings with step 31 in the Configuration menu. Only the language setting (step 30 in the Configuration menu) remains unchanged.

! The necessary controller settings are explained in the detailed functional descriptions in section 9.5 "Menu steps" on page 28 and section 9.14 "Time control (timer function)" on page 40. They are only allowed to be entered by technically trained persons.

Please refer to section 10 "Factory settings" on page 52 for more information about the factory settings.

(•) Factory setting

The timer function is activated with step 37 in the Configuration menu:

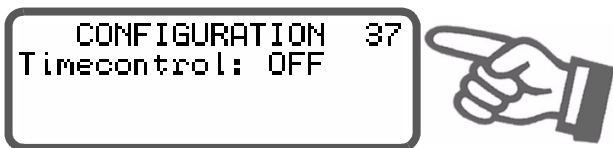

8.3.6 Relay K1 (without time control)

The function of relay K1 is specified with step 39 in the Configuration menu:



The following settings are possible when time control is deactivated:

1. **"Off" (•)**
Relay K1 has no function
2. **"Active if Tact = Tset"**
Relay K1 is switched according to the "Temperature OK" signal. This relay thus has the same function as the output at terminals 20+21 (↪ section 9.11 "Temperature OK" signal" on page 38).

Other settings are available in this menu when time control (timer function) is active. They are described in section 9.14.6 "Relay K1 (with time control)" on page 43.

8.3.7 Configuration of the alarm relay

The alarm relay is set with step 43 in the Configuration menu:

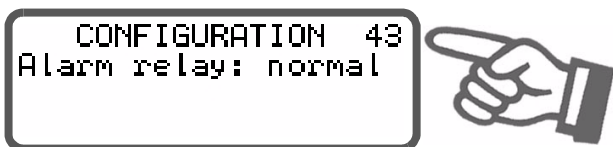

There are two possible settings:

1. **"Normal" (•)**
Alarm relay contact closed by alarm
2. **"Inverse"**
Alarm relay contact opened by alarm

(•) Factory settings

8.4 Startup procedure

Prerequisites: The controller must be correctly installed and connected (↪ section 7 "Installation" on page 12). The possible settings are described in detail in section 9 "Controller functions" on page 21 and section 8.3 "Controller configuration" on page 17. The essential controller configurations are described below:

1. Switch off the line voltage and verify the safe isolation from the supply.
2. The supply voltage specified on the nameplate of the controller must be identical to the line voltage that is present in the plant or machine. The line frequency is automatically detected by the temperature controller in the range from 47 to 63Hz.
3. The settings of the DIP switches on the controller depend on the ROPEX Application Report and the heatsealing band that is used (section 8.3 "Controller configuration" on page 17).
4. Make sure that no START signal is present.
5. Switch on the line voltage.
6. A power-up message appears on the display for approximately 2 seconds when the controller is switched on to indicate that it has been started up correctly.
7. One of the following states then appears:

DISPLAY	ACTION
Main menu	Go to 8
Alarm signal with error codes 104...106, 111...113, 211	Go to 8
Alarm signal with error codes 101...103, 107, 108, 201...203, 801, 9xx	Fault diagnosis (↪ 9.24)

8. Set the controller configuration as described in section 8.3 "Controller configuration" on page 17. The following settings are always required:

Setting	Step in Configuration menu
Language	30
Restore factory settings	31
Temperature range and heat-sealing band alloy	32

9. Activate the AUTOCAL function while the heat-sealing band is still cold (with step 7 in the Settings menu or by means of the "AUTOCAL" signal, terminals 20+25). The progress of the calibration process is indicated by a counter on the display (approx. 10...15s). A voltage of 0VDC appears at the same time at the actual value output (terminals 20+24). If an ATR-3 is connected, it indicates 0°C.

When the zero point has been calibrated, the display is reset to the home position and 20°C is indicated as the actual value. A voltage of 0.66VDC, equivalent to 20°C, appears at the actual value output. If an ATR-3 is connected, it must be set to "Z" (20°C).

If the zero has not been calibrated successfully, an alarm signal indicates error codes 104...106, 211. In this case the controller configuration is incorrect (↪ section 8.3 "Controller configuration" on page 17 and ROPEX Application Report). Repeat the zero point calibration after the controller has been configured correctly.

10. When the zero point has been calibrated successfully, the main menu appears on the display again. Then specify a defined temperature (heat-sealing temperature) with step 1 in the Settings menu (or apply a 0...10VDC voltage to the analog input, terminals 20+23) and activate the "START"

signal (HEAT). Alternatively, a heatsealing process can be started by pressing the "HAND" key (display in menu „manual impulse“ step 7). The indication of the ACTUAL temperature on the display (digital value and dynamic bar) permits the heating and control process to be observed:

The controller is functioning correctly if the temperature indicated on the display has a continuous curve, in other words it must not jump abruptly, fluctuate or deviate temporarily in the wrong direction. This kind of behavior would indicate that the U_R measuring wire has been laid incorrectly.

If an error code is displayed, please proceed as described in section 9.24 "Error messages" on page 49.



If the heatsealing temperature is selected via the analog input at terminals 20+23, the specified voltage value must be checked with a voltmeter before the heatsealing process begins, in order to prevent incorrect settings or excessively high heatsealing temperatures.

The controller is now ready

9 Controller functions

9.1 Indicators and controls

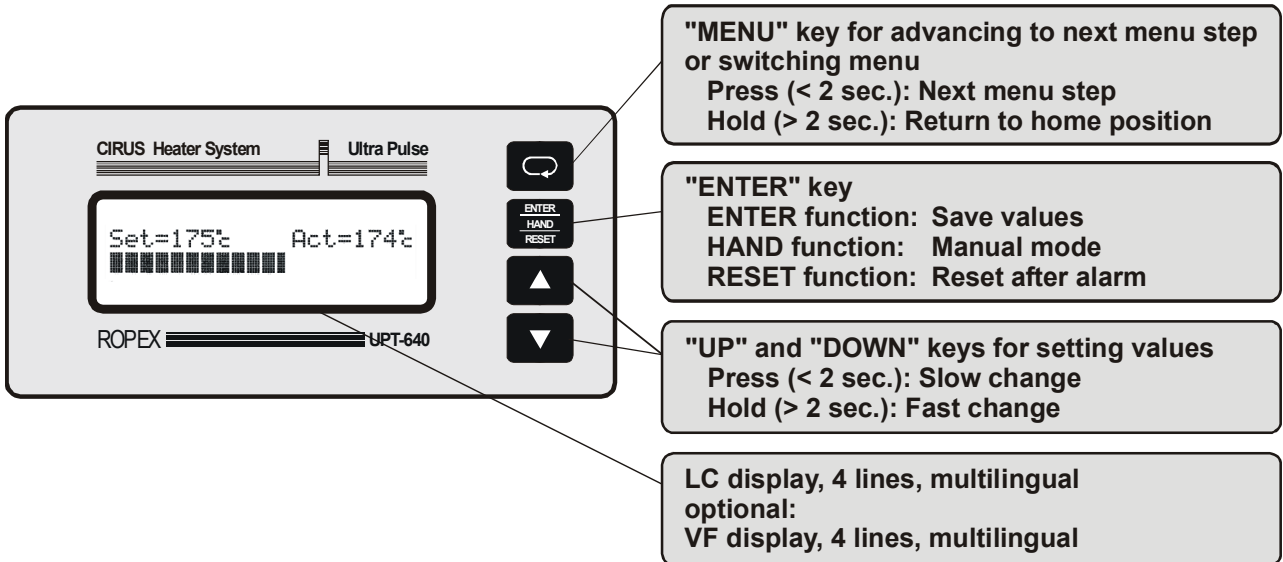

9.2 Display

This message also includes details of the software version.

9.2.1 Power-up message

A power-up message appears on the display for approximately 2 seconds when the controller is switched on.

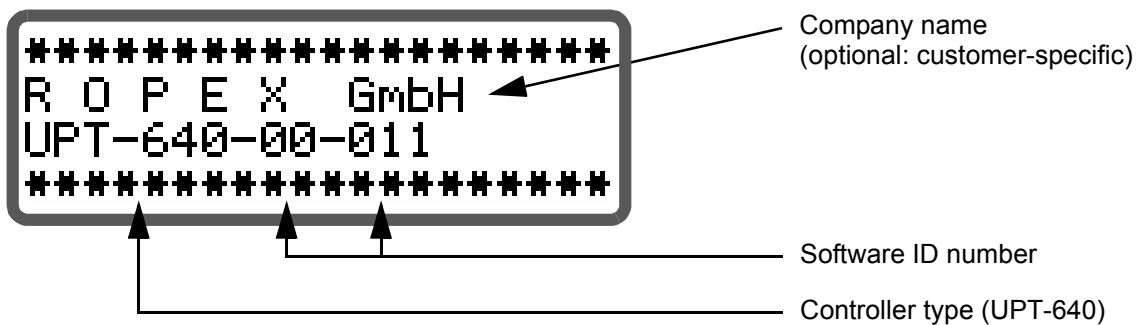

9.2.2 Display in home position

If no settings are entered on the controller and no alarm signals are present, the display is in the home position, in other words it indicates the SET temperature as a

digital value and the ACTUAL temperature as a digital value and a dynamic bar. If time control (timer function) is active, the time control settings are also displayed.

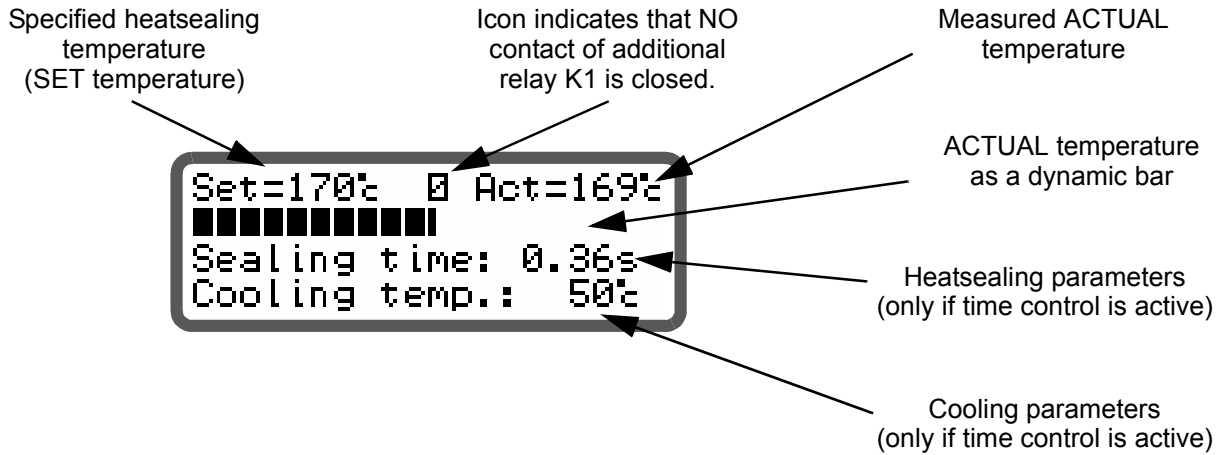

9.2.3 Settings/Configuration menus

The required parameters are set on two menu levels: the Settings (control) menu and the Configuration menu (↪ section 9.4 "Menu structure" on page 26).

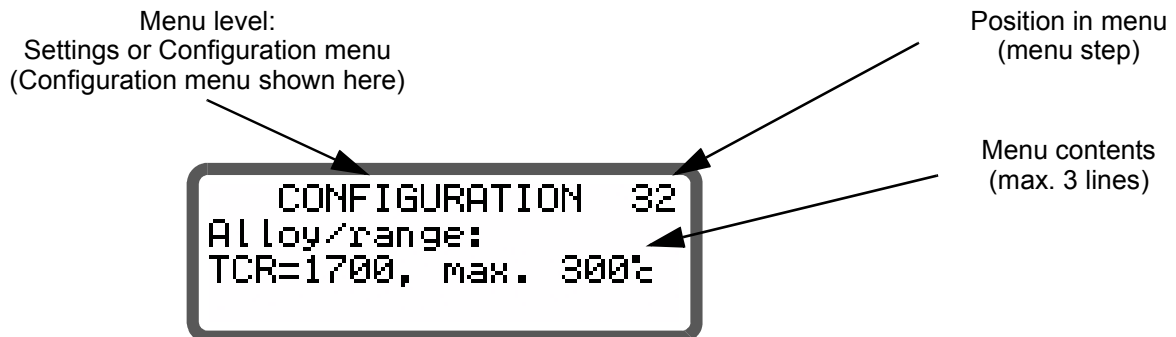

9.2.4 Alarm signals

The fault diagnosis function of the controller is always active. If a fault is detected, it is indicated on the display

immediately in the form of an alarm signal (↪ section 9.23 "System monitoring/alarm output" on page 48).

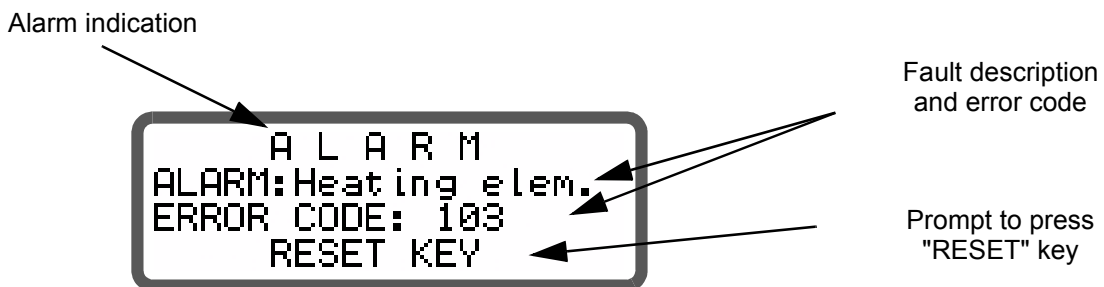

9.3 Navigation in the menus

9.3.1 Navigation in menus without an alarm

A power-up message appears on the display for approximately 2 seconds when the UPT-640 is switched on. The display then changes to the selection menu. You can select the required menu branch (Sealing Cycle, Release Impulse, Manual Impulse or Configuration) in the selection menu with the "UP" and "DOWN" keys and then open this branch by pressing the "Enter" or "Menu" key.

A "MENU" key is provided for navigating through the various menu steps and levels. By pressing this key briefly (<2s) at any time, you can jump to the next menu step. By pressing the key for longer (>2s), you can return to the home position from anywhere in the menu structure, providing a controller alarm is not active. In this case, the Alarm menu is opened instead. In addition, you always return to the home position if you do not press any keys for a period of 30s. There is no automatic return after 30s from "AUTOCAL" or "Alarm".

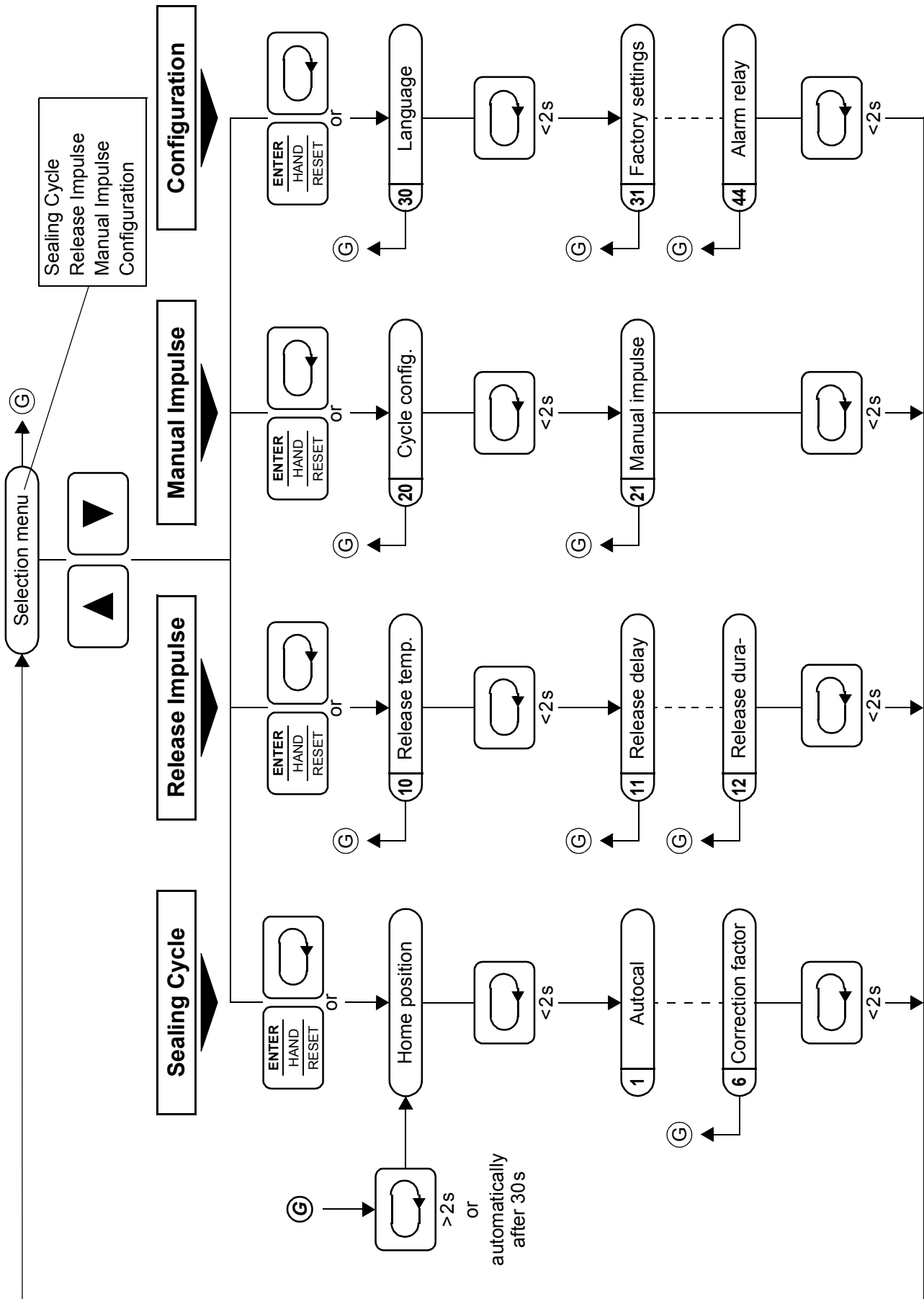

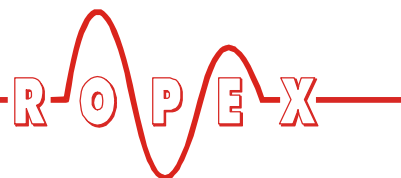

9.3.2 Navigation in menus with an alarm

If an alarm is signaled, the controller switches to the Alarm menu. Some faults can be acknowledged by pressing the "RESET" key (↵ section 9.23 "System monitoring/alarm output" on page 48). In this case, the controller switches back to the selection menu.

If the fault can be rectified by executing the AUTOCAL function, you can select the "AUTOCAL" menu step directly by briefly pressing the "MENU" key (<2s). You can then activate the "AUTOCAL" function by pressing the "ENTER" key (↵ section 9.8 "Automatic zero calibration (AUTOCAL)" on page 36).

9.4 Menu structure

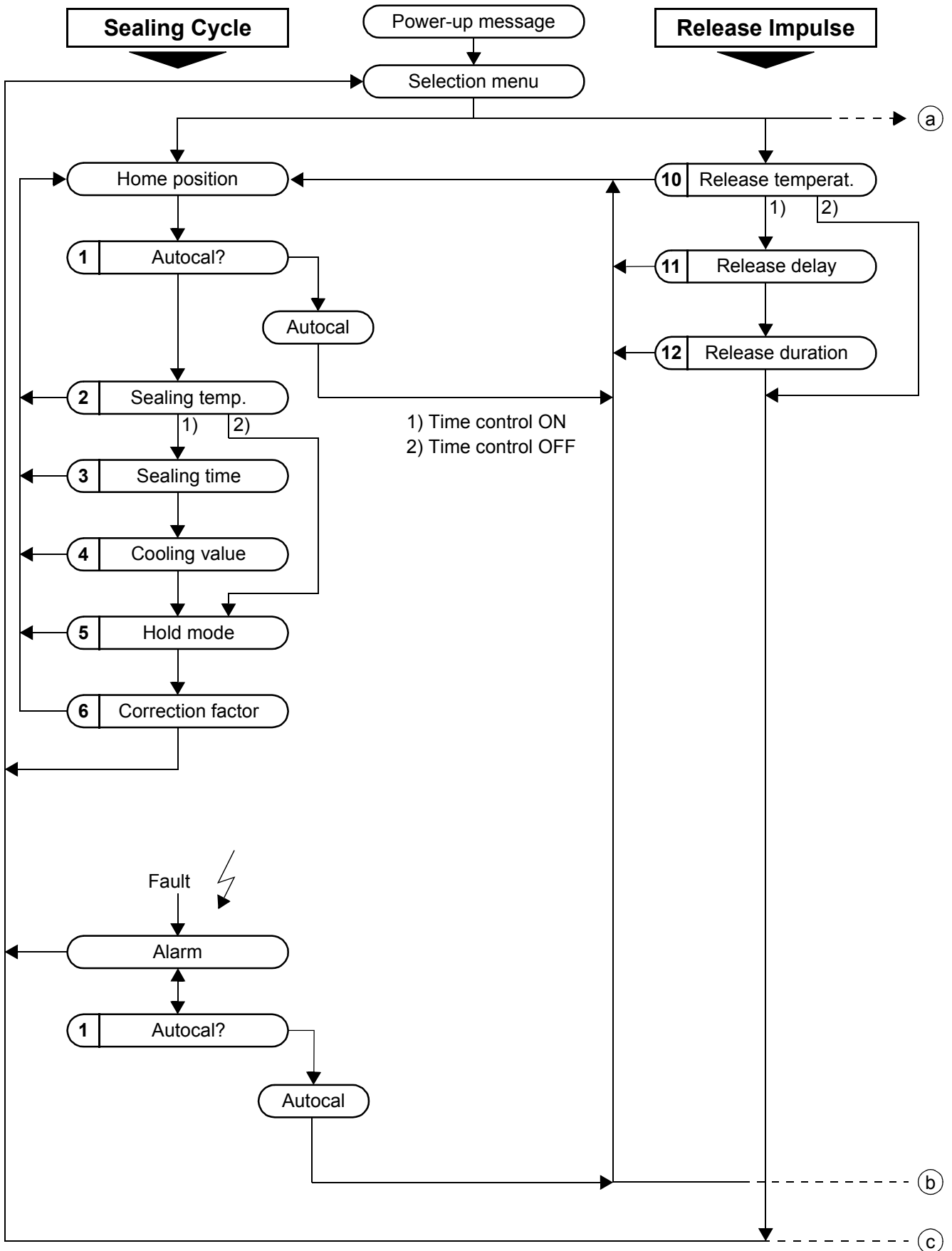

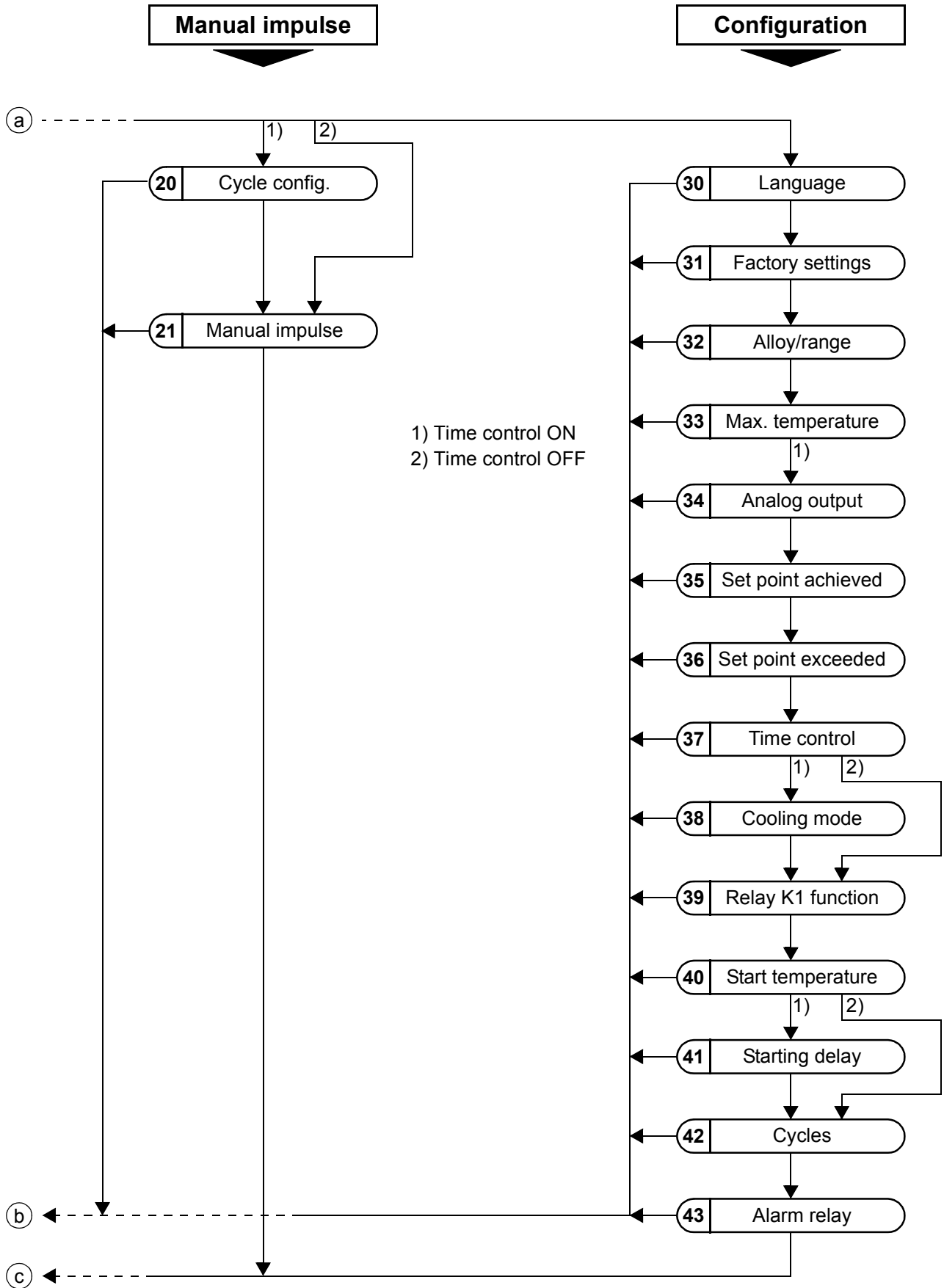

9.5 Menu steps

No.	Name	Description	Setting range	Factory sett.
	Selection	You can navigate from the selection menu to the required menu branch. The required branch can be selected with the "UP" and "DOWN" keys. The currently selected branch is indicated by an arrow on the right-hand side of the display. After you have selected a branch, you can open it by pressing the "MENU" or "ENTER" key.	Sealing Cycle Release Impulse Manual Impulse Configuration	
Sealing Cycle				
	Home position	The specified set value and the current actual value are displayed in digital form. The actual value is also represented as a dynamic bar. If time control (step 38) is active, the heatsealing time and the cooling value are also displayed.		
1	Autocal	The AUTOCAL function matches the controller to the current and voltage signals that are present in the system. The required calibration temperature can be set with the "UP" and "DOWN" keys. Pressing the "ENTER" key stores the set value and starts the "AUTOCAL" function. The word "- Calibration -" appears on the display while the AUTOCAL function is executing and a counter counts down from 13 to 0. When the controller has been calibrated successfully, the display switches back directly to the home position. If the controller cannot be calibrated, the AUTOCAL function is aborted and an error message is displayed instead.	0...40°C	20°C
2	Heatsealing temperature	The required heatsealing temperature (set point) can be set with the "UP" and "DOWN" keys. The maximum selectable set point can be limited with step 32 (alloy/range) and step 33 (max. temperature). If the heatsealing temperature is to be determined by a voltage at the analog input at terminals 20+23, it must be set to 0°C with this menu step. The set point is indicated in the home position.  If an external heatsealing temperature (analog input, terminals 20+23) and an internal heatsealing temperature (step 2) are specified simultaneously, the higher of the two temperatures is used and indicated in the main menu.	Depends on setting of step 32: 0, 40°C...maximum temperature (step 33)	0°C

No.	Name	Description	Setting range	Factory sett.
3	Heatsealing time	The length of the heatsealing impulse can be set with the "UP" and "DOWN" keys. The specified heatsealing time is indicated in the home position. This function can only be selected if time control (step 37) is active.	0...5.00s	0.10s
4	Cooling value	<p>The cooling value can be specified here according to the cooling mode (absolute, relative, time) selected with step 38. The cooling value is indicated in the home position.</p> <ul style="list-style-type: none"> Absolute: The cycle ends if the "cooling temperature" falls below the set value (in °C). Relative: The cycle ends if the "cooling temperature" falls below the set percentage value, whereby 100% corresponds to the specified set point (step 2). Time: The cycle ends when the set "cooling time" in seconds has elapsed. The current cooling value is indicated in the home position. <p>This function can only be selected if time control (step 37) is active.</p>	<p>50°C to maximum temperature (step 33)</p> <p>40%...100%</p> <p>0...9.99s</p>	<p>50°C</p> <p>40%</p> <p>1.00s</p>
5	Hold mode	<p>If the "Hold" function is activated, the last measured value at the end of the heating phase is stored and displayed.</p> <p>The "Act" (actual value) information in the home position is replaced by "Hold". This procedure is repeated for every cycle and the displayed value is updated. The word "Hold" is invisible for 100ms before the value is updated.</p> <p>If you select the "2 second hold" function, the display changes back from hold mode to the actual value in real time after 2 seconds. The hold function is then activated again for 2 seconds at the end of the next cycle.</p>	<p>ON</p> <p>OFF</p> <p>2 sec</p>	OFF
6	Correction factor	<p>The correction factor permits the controller to be adapted to the customer's application (type of UPT heating element, impulse transformer specification, length of connecting wires, cooling etc.). You can set a suitable correction factor here.</p> <p> The correction factor can also be set with steps 20 and 21 (Manual Impulse).</p>	25...200%	100%

No.	Name	Description	Setting range	Factory sett.
Release Impulse				
10	Release temperature	<p>The required release temperature can be set with the "UP" and "DOWN" keys. The maximum value is determined by the settings in step 32 (alloy/range) and step 33 (max. temperature). The release impulse can be deactivated by entering 0°C. If the "External release impulse" option is selected in step 37, the release temperature can also be selected by applying a corresponding voltage signal at the analog input (terminal 23).</p> <p> If an external release temperature (analog input, terminals 20+23) and an internal release temperature (step 10) are specified simultaneously, the higher of the two temperatures is used.</p>	Depends on setting of step 32: 0, 40°C...maximum temperature (step 33)	0°C
11	Release delay	<p>A delay time between the end of the cooling phase and the start of the release impulse can be set with the "UP" and "DOWN" keys. This step can only be selected if time control (step 37) is active. If the "External release impulse" option is selected in step 37, the delay time is triggered by a 24 VDC signal either at terminals 22+4 or at terminals 19+2 ("release impulse").</p>	0...9.99s	2.00s
12	Release duration	<p>The duration of the release impulse can be set with the "UP" and "DOWN" keys. The impulse duration starts after the delay time has elapsed. This step can only be selected if time control (step 37) is active. If the release impulse is generated internally (step 37), it can be deactivated by entering 0s. If the "External release impulse" option is selected in step 37 and the impulse duration is set to 0seconds, this duration is equal to the time for which the signal is applied to terminal 22 or terminal 19, whereby the maximum impulse duration is limited to 5.00seconds.</p>	0...5.00s	0.00s

No.	Name	Description	Setting range	Factory sett.
Manual Impulse				
20	Cycle	The correction factor can be set in this menu step with the "UP" and "DOWN" keys. A heatsealing cycle (without a release impulse) can be started with the active parameters by pressing the "HAND" key. The set point, the actual value, the heatsealing time (St), the cooling value (Ct = time, Cabs = absolute, Crel = relative) and the correction factor are displayed. This step can only be selected if time control (step 37) is active.	25...200%	100%
21	Permanent heating	The correction factor can be set in this menu step with the "UP" and "DOWN" keys. The controller heats the heating element to the set point when the "HAND" key is pressed. The heatsealing time is equal to the time for which the key is actuated. It is limited to a maximum of 5.00seconds. The set point, the actual value and the correction factor are displayed.	25...200%	100%
Configuration				
30	Language	The desired display language can be selected with this menu step.	English German As of SW revision 017 also: Italian	German
31	Factory settings	The controller can be reset to the factory settings by pressing the "ENTER" key. The default values are loaded in the controller again (↩ section 10 "Factory settings" on page 52).		
32	Alloy/range	Various temperature ranges can be selected here. The corresponding characteristic for the controller parameters is calculated on the basis of this setting. The temperature range setting permits the controller to be matched to the required operating range. This also determines the scale for the bar display and the analog output.	TCR 1700ppm, 200°C TCR 1700ppm, 300°C	1700ppm, 300°C
33	Maximum temperature	This menu item specifies the maximum selectable set point (step 2) within the range defined by step 32.	0 to max. temperature range (step 32)	300°C
35	Analog output	You can choose whether to output the current actual value or a 10V reference voltage at the TEMP. OUT output (terminal 24).	Real temperature 10V reference	Real temperature

No.	Name	Description	Setting range	Factory sett.
35	Set point reached (low limit)	<p>If the actual value is greater than the switching threshold specified here and less than the threshold set with step 36, the "Temperature OK" output is activated.</p> <p>The value is entered in Kelvins (K) and subtracted from the set point in order to calculate the switching threshold.</p>	-5K...-99K	-10K
36	Set point exceeded (high limit)	<p>If the actual value is less than the switching threshold specified here and greater than the threshold set with step 35, the "Temperature OK" output is activated.</p> <p>The value is entered in Kelvins (K) and added to the set point in order to calculate the switching threshold.</p>	+5K...+99K	+10K
37	Time control	<p>This menu step specifies whether the controller should operate with or without time control. You can also specify whether the release impulse (step 11, delay and step 12, duration) should be controlled internally by the controller or by an external signal (terminals 22+4 or 19+2). In both cases, either the value set in step 10 or the external set point (terminals 23+20) is used as the release temperature.</p>	OFF ON, with external release impulse ON, with internal release impulse	OFF
38	Cooling mode	<p>The end of the cooling-down phase (end of cycle) can be configured by specifying the required cooling mode.</p> <ul style="list-style-type: none"> • Absolute: The cycle ends if the actual value falls below the cooling temperature set here. • Relative: The cycle ends if the actual value falls below the relative cooling temperature (percentage of the set point) set here. • Time: The cycle ends when the set cooling time has elapsed. <p>This function can only be selected if time control (step 37) is active.</p>	Absolute (in °C) Relative (in %) Time (in s)	Absolute

No.	Name	Description	Setting range	Factory sett.
39	Relay K1 function	<p>The energizing behavior of relay K1 can be configured as follows:</p> <p>Time control OFF:</p> <ul style="list-style-type: none"> • K1 is not activated • K1 is energized if the "Temperature OK" output is active 	<p>Relay K1 OFF</p> <p>Relay K1 switches when Tact = Tset</p>	Switches when Tact = Tset
		<p>Time control ON:</p> <ul style="list-style-type: none"> • K1 is not activated • K1 is energized if the start signal is present. The relay is deenergized at the end of the cooling phase. • K1 is energized if the actual value reaches 95% of the set point. The relay is deenergized at the end of the cooling phase. • K1 is energized while cooling is active • K1 is energized for up to 0.5 seconds at the end of the cooling phase (momentary impulse). The length of the momentary impulse can be shortened by applying the start signal (during the impulse). 	<p>Relay K1 OFF</p> <p>Relay K1 switches when START signal present</p> <p>Relay K1 switches when temperature reached</p> <p>Relay K1 active while cooling</p> <p>Relay K1 generates end-of-cycle impulse</p>	
40	Starting temperature	<p>A temperature threshold which is evaluated when the "START" signal is activated can be set with the "UP" and "DOWN" keys.</p> <p>If the current actual value is higher than this threshold when the "START" signal is activated, the controller reports an ALARM. An error message is displayed to indicate this and the heatsealing band is no longer heated up.</p>	Depends on setting of step 32: 20°C...maximum temperature (step 33)	100°C
41	Starting delay	<p>This option allows the heatsealing time to be preceded by a starting delay. This delay time begins as soon as the start signal is applied. When it elapses, the heatsealing time is activated.</p> <p>This function can only be selected if time control (step 37) is active.</p>	0...9.99s	0.00s
42	Cycles	<p>The number of heating impulses (not manual impulses) is counted and displayed with this menu step. The counter can be reset either by pressing the "ENTER" key or by restoring the factory settings.</p>	Reset with "ENTER" key	0

No.	Name	Description	Setting range	Factory sett.
43	Alarm relay	<p>This menu step permits the switching characteristics of the alarm relay to be configured.</p> <ul style="list-style-type: none"> • Normal: The alarm relay output (terminals 5+6) operates as an NO contact in the event of an alarm. • Inverse: The alarm relay output (terminals 5+6) operates as an NC contact in the event of an alarm. 	<p>normal</p> <p>inverse</p>	normal

9.6 Temperature setting (set point selection)

The heatsealing temperature can be set on the UPT-640 controller in three ways:

- By means of the setting in step 2.

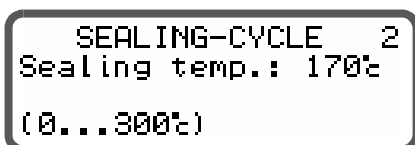

- By applying a 0...10VDC voltage to the analog input at terminals 20+23.

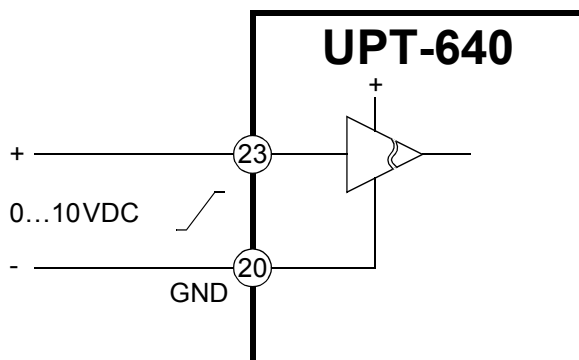

The relationship between the applied voltage and the SET temperature is linear.

Voltage values:

0VDC → 0°C

10VDC → 300°C

Please refer to section 9.7 "Temperature indication/ actual value output" on page 35 for a circuit diagram.

If the heatsealing temperature is to be determined by a voltage at the analog input at terminals 20+23, it must be set to 0°C with step 2.

! If an external heatsealing temperature (analog input, terminals 20+23) and an internal heatsealing temperature (step 2) are specified simultaneously, the higher of the two temperatures is used and indicated in the home position.

! The maximum value of the setting range is limited either by the maximum value specified with step 33 in the Configuration menu or by the heatsealing band type/temperature range set with step 32.

The set point that is selected for the heatsealing temperature must be greater than 40°C. If not, the heatsealing band will not be heated up when the "START" signal is activated or the "HAND" key is pressed in menu "manual impulse" (step 20/21).

The set heatsealing temperature is displayed in the main menu once it has been entered.

! If the heatsealing temperature is specified via the analog input at terminals 20+23, the external voltage must be activated at least 100ms before the heatsealing process starts. If not, the heatsealing temperature will not reach the required value.

- By connecting a 2kohm potentiometer (e.g. PD-3) to terminals 20, 23 and 24.

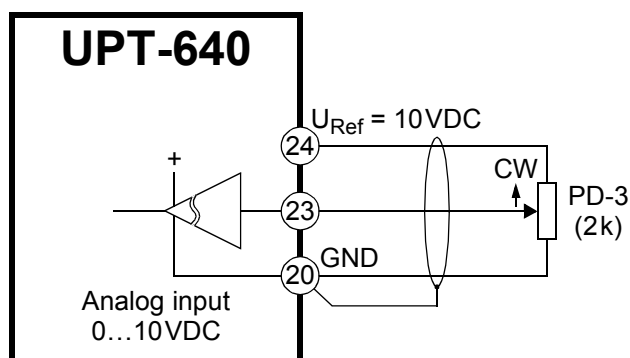

Potentiometer with digital dial PD-3

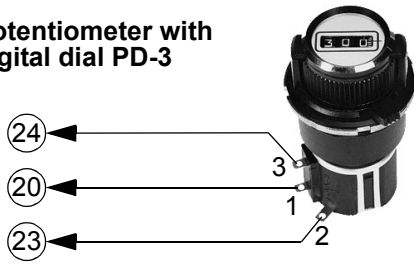

The controller is configured for this purpose so that a fixed 10VDC reference voltage is available at the analog output at terminal 24 (→ menu step 34, section 9.7 "Temperature indication/actual value output" on page 35).

This voltage is divided by the PD-3 set point potentiometer and supplied to the analog input at terminal 23. You can then specify the set temperature in °C in the digital window of the potentiometer.

Once again, the set temperature must be set to zero in step 2.

9.7 Temperature indication/actual value output

If the display is in the home position, the ACTUAL temperature is indicated there as a digital value and as a dynamic bar.

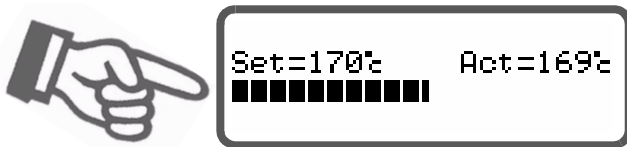

The heating and control process can thus be observed at any time.

In addition, the UPT-640 controller outputs an electrically isolated, analog 0...10VDC signal, which is pro-

portional to the real ACTUAL temperature, at terminals 20+24t

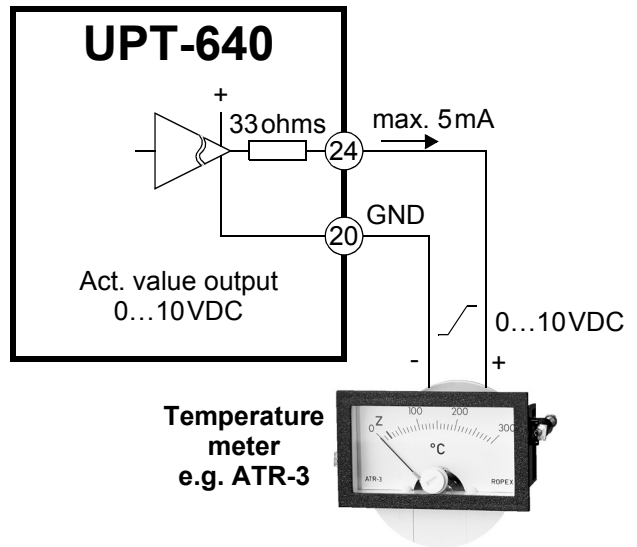

Voltage values:

0VDC → 0°C

10VDC → 300°C

The relationship between the change in the output voltage and the ACTUAL temperature is linear.

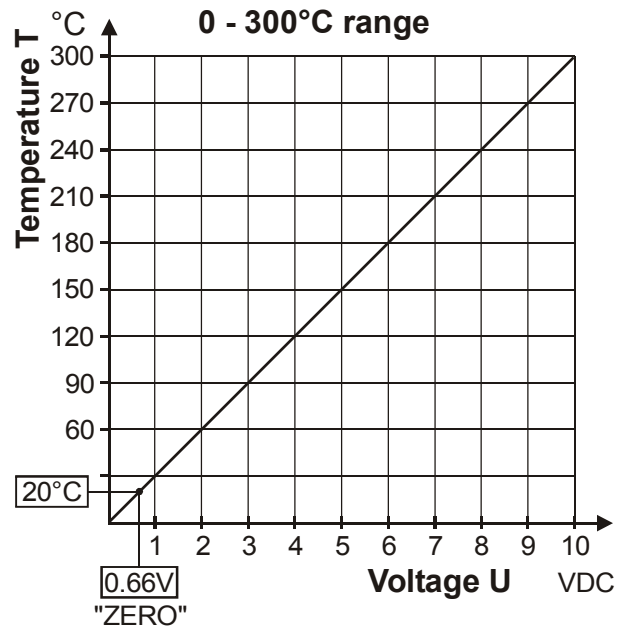

If a temperature range of 200°C is set for the controller with step 32 in the Configuration menu, it appears at this output in the 0...300°C range.

An indicating instrument can be connected to this output in order to visualize the temperature of the heating element.

The characteristics of the ROPEX ATR-3 temperature meter (size, scaling, dynamic response) are ideally

suited to this application (↪ section 4 "Accessories and Modifications" on page 6).

It not only facilitates SET-ACTUAL comparisons, but also enables other criteria such as the heating rate, set point reached within the specified time, cooling of the heatsealing band etc. to be evaluated.

This meter moreover permits disturbances in the control loop (loose connections, contacting or wiring problems) as well as any line disturbances to be observed extremely effectively and interpreted accordingly. The same applies if mutual interference occurs between several neighboring control loops.

If an alarm is signaled, this analog output is used – in addition to the value indicated on the controller – to display a selective error message (↪ section 9.24 "Error messages" on page 49).

If you want a fixed 10V reference voltage to appear at the analog output (terminal 24), you can configure this in step 34 (analog output):

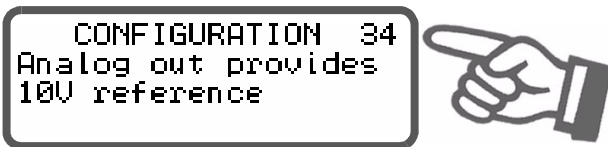

- Actual temperature (•)
The TEMP. OUT output indicates the current ACTUAL VALUE as a 0...10VDC analog voltage.
- 10V reference
A fixed 10VDC reference voltage is output at the TEMP. OUT output.

9.8 Automatic zero calibration (AUTOCAL)

Thanks to the automatic zero calibration (AUTOCAL) function, there is no need to adjust the zero point manually on the controller. The "AUTOCAL" function matches the controller to the current and voltage signals that are present in the system. This function can be activated in two ways:

- By means of a 24VDC signal at terminals 20+25.

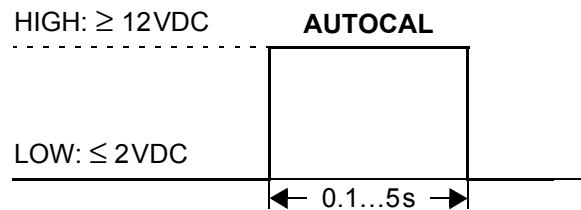
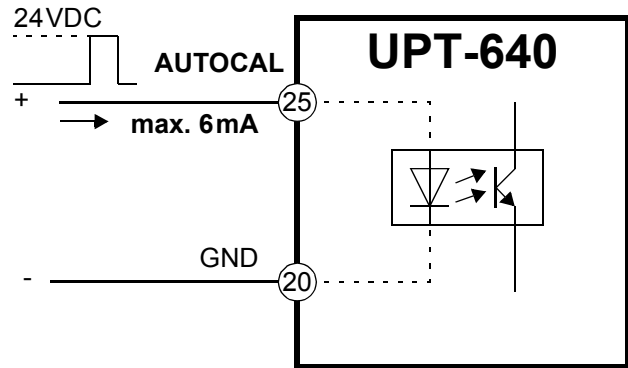

- By selecting step 1 in the Settings menu and pressing the "ENTER" key

The currently valid initial temperature (ambient temperature) for calibrating the heatsealing bar(s) can be set beforehand in the 0...40°C range using the "UP" and "DOWN" keys.

The zero point is calibrated in the factory to 20°C.



The automatic calibration process takes around 10...15 seconds. The heatsealing band is not heated additionally.

The message "- Calibration - Please wait..." appears on the display while the "AUTOCAL" function is executing and a counter counts down from 13 to 0. The actual value output (terminals 20+24) is set to 0°C (corresponds to 0 VDC) for the duration of the calibration process.



⚠ You must always wait for the heating element to cool down (to ambient temperature) before activating the "AUTOCAL" function.

(•) Factory setting

Reasons for disabled AUTOCAL function:

1. The "AUTOCAL" function is not activated if the heat-sealing band cools down at a rate of more than 0.1K/second. This is additionally indicated with step 1 in the Settings menu by the message "Heating elem. warm! Please wait...".
2. If the "START" signal or release impulse (24VDC or contact) is activated, the AUTOCAL function is not executed. As of software revision 017 this is additionally indicated with step 1 in the Settings menu by the message „Autocal locked ! (START-Sig. active)" or „Autocal locked ! (RELEASE-Sig. active)".
3. Directly after the controller is powered up, the AUTOCAL function cannot be activated if a fault with error code 101...103, 201...203, 801 or 9xx occurs (↪ section 9.24 "Error messages" on page 49). If the controller has already operated correctly - a minimum of once - after powering up, the AUTOCAL function cannot be activated with error codes 201...203, 801 or 9xx.

9.9 "START" signal (HEAT)

The heating process is activated by means of the "START" signal in different ways, depending on the time control status (timer function) (↪ Configuration menu, step 37) :

1. Time control off (deactivated):

When the "START" signal is activated, the controller-internal set/actual comparison is enabled immediately and the heatsealing band is heated up to the SET temperature. It remains at this temperature until the signal is deactivated again. This process can also be started independently of the "START" signal by pressing the "HAND" key while the display is in the menu "manual impulse" (step 21).

⚠ The maximum duration of the heating process is limited internally by the controller to 5seconds, in order to avoid damaging the heating element. If this time limit is exceeded, heating is terminated automatically (Software release 011 or higher).

2. Time control on (activated):

If time control (timer function) is on, activating the "START" signal starts the internally parameterized timeout. The time at which the heatsealing band begins to heat up depends on the setting of this parameter. The "START" signal must be deactivated

again before the next timeout is activated.

Pressing the "HAND" key in step 21 (permanent heating) causes the heatsealing band to start heating up immediately (as described in 1). The internal timeout does not start.

If the "HAND" key is pressed in step 20 (cycle), the controller executes a complete heatsealing cycle (without a release impulse).

The "START" signal can be activated in two ways:

- By means of a 24VDC signal at terminals 3+4.

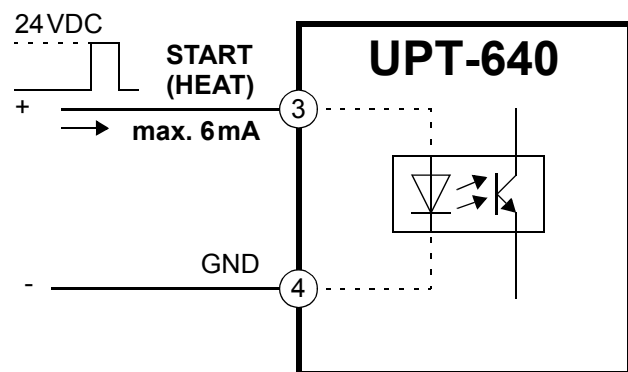

HIGH: $\geq 12\text{VDC}$

LOW: $\leq 2\text{VDC}$

START (HEAT)
or
START TIMER

- By means of a control contact at terminals 2+7

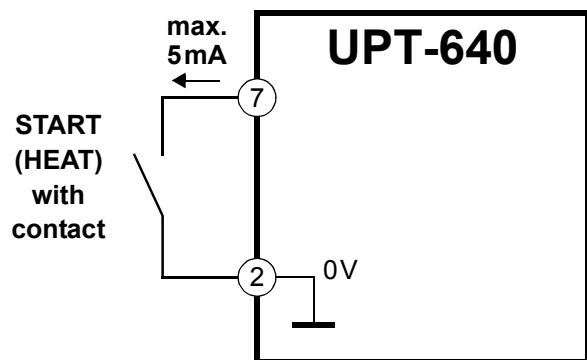

⚠ All attempts to activate the "START" signal will be refused as long as the AUTOCAL function is executing in the Settings menu (with step 1).

The set point that is selected for the heatsealing temperature (step 2 in the Settings menu) must be greater than 40°C. If not, the heating element will not be heated up.

The alarm relay is switched if the "START" signal is activated while an alarm signal is indicating error codes 104...105, 111...113 or 211 (↪ section 9.24 "Error messages" on page 49). The heating element is likewise not heated.

9.10 "RESET" signal

The CIRUS temperature controller UPT-640 can be reset by means of an external "RESET" signal at terminals 20+26.

As a result:

- A heatsealing cycle is aborted if one is in progress
- No more measuring impulses are generated
- An alarm signal is reset if one is present

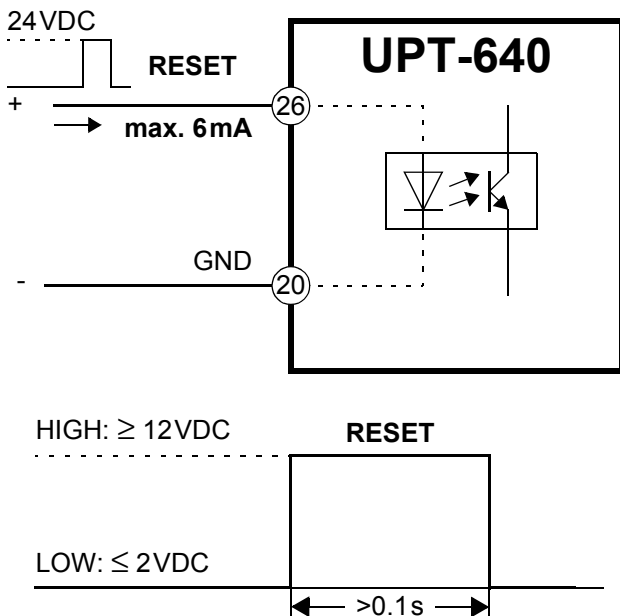

The "AUTOCAL" function is not aborted if the "RESET" signal is activated while it is still executing.

! The controller performs an internal initialization for approximately 500ms after the "RESET" signal is deactivated. The next heat-sealing process cannot be started until it has finished.

! If a contactor K2 is used to deactivate the control loop (↪ Kap. 7.3 „Power supply“ auf Seite 13), it must be energized again 50ms at the latest after the "RESET" signal is deactivated. If it is energized too late, an alarm signal will be output by the controller.

9.11 "Temperature OK" signal

The UPT-640 checks whether the ACTUAL temperature is within a settable tolerance band ("OK" window) on either side of the set temperature. The lower ($\Delta\vartheta_{lower}$) and upper ($\Delta\vartheta_{upper}$) limits of the tolerance band can be changed independently of one another by means of steps 35+36 in the Configuration menu.

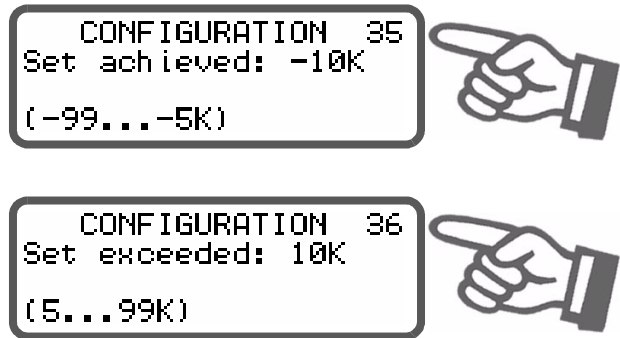

If the actual temperature is inside the specified tolerance band, the output at terminals 20+21 is switched (see graph below):

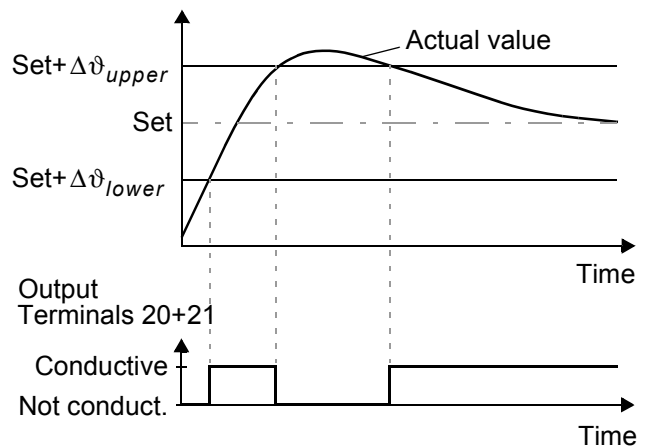

The "Temperature OK" signal is available at terminals 20+21 as a digital control signal.

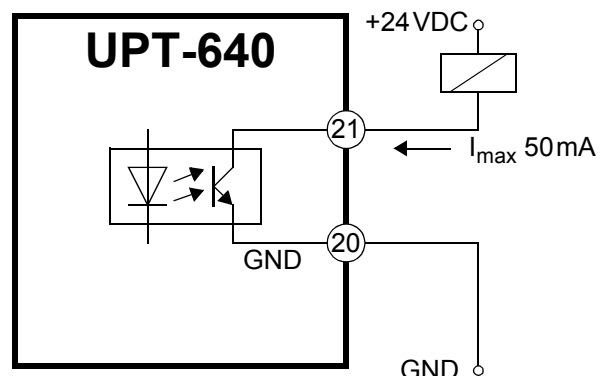

! The **ACTUAL** temperature is evaluated, and the output signal at terminals 20+21 activated, in all operating states except when an alarm is signaled.

If time control is deactivated, relay K1 can also be switched simultaneously with this signal. This permits loads with higher currents to be controlled (↪ section 8.3.6 "Relay K1 (without time control)" on page 19).

9.12 Cycle counter

Each activation of the "START" signal during operation is detected by a cycle counter integrated in the controller. Actuations of the "HAND" key are not counted. The counter reading can be displayed with step 42 in the Configuration menu:

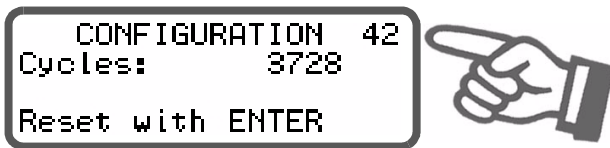

The cycle counter is reset to 0 if the "ENTER" key is pressed or if the maximum count of 999.999.999 cycles is exceeded.

9.13 Hold mode

The behavior of the digital indication of the ACTUAL temperature in the home position can be changed with step 5 in the Settings menu:

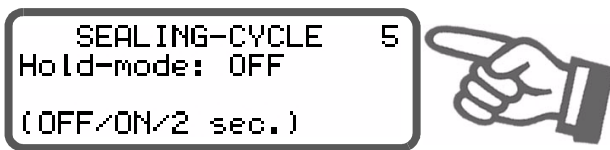

The following settings are possible:

1. **"OFF" (•)**
If the main menu is visible on the display, the real ACTUAL temperature is always indicated.
2. **"ON"**
If the display is in the home position, the ACTUAL temperature that was valid at the end of the last heatsealing phase is always indicated as a digital value. When the controller is switched on, the real

(•) Factory setting

ACTUAL temperature is indicated until the end of the first heating phase.

3. "2 s"

This setting causes the current ACTUAL temperature to be displayed as a digital value for an additional 2 seconds at the end of a heatsealing phase. This temperature is then indicated again in real time until the end of the next heating phase.

! Hold mode only affects the digital value on the display. The ACTUAL temperature in real time is always indicated, regardless of the setting, by the dynamic bar and the actual value output.

The various hold modes are shown below:

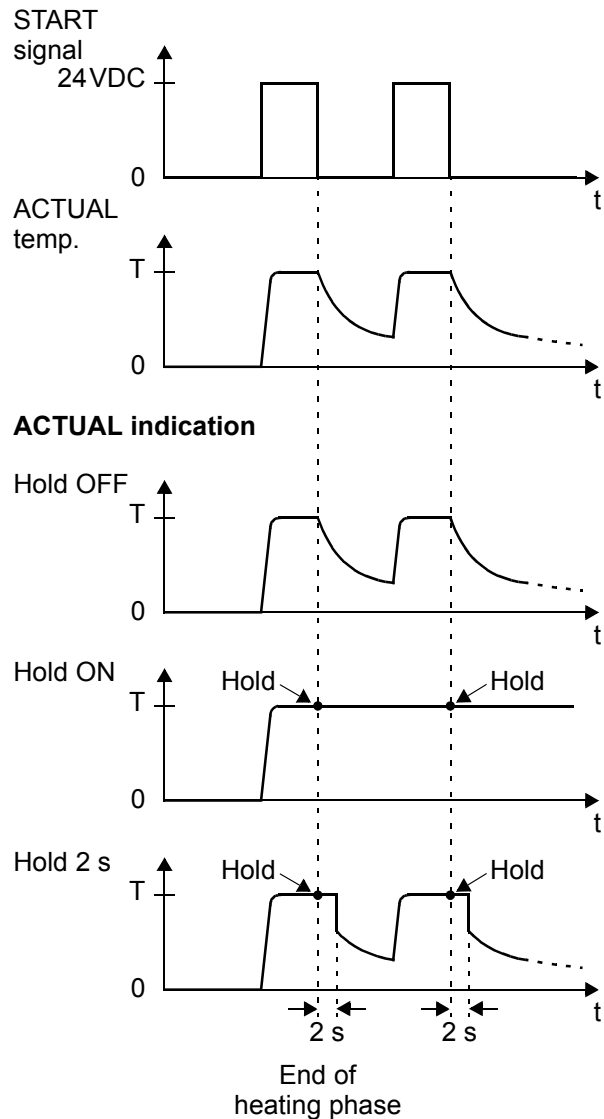

The word "Hold" appears on the display if a temperature value is indicated in hold mode. It disappears for

approximately 100ms whenever the hold value is updated.

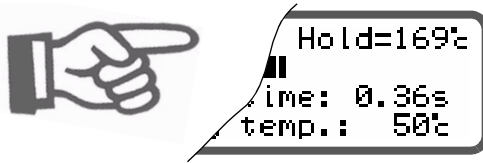

- Cooling phase
- Relay K1 function.

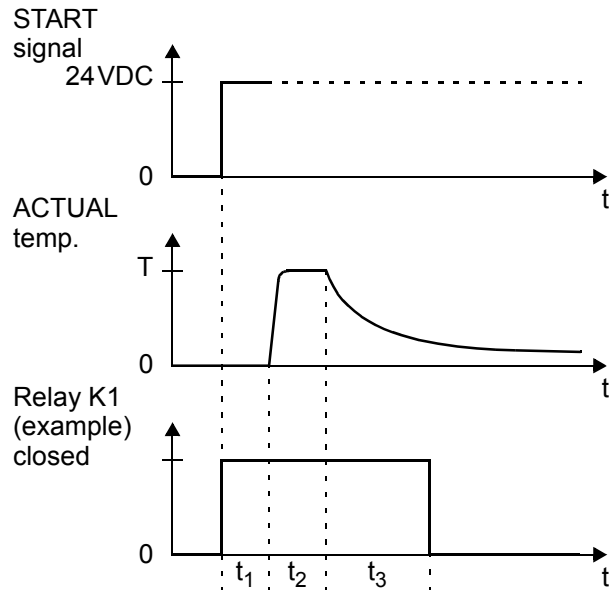

t_1 = Starting delay
 t_2 = Heating phase
 t_3 = Cooling phase

9.14 Time control (timer function)

9.14.1 Activation and indication

! The settings described here are only allowed to be entered by technically trained persons. An incorrectly parameterized timer function may cause disruptions to operation and damage to the machine.

The timer function is activated with step 37 in the Configuration menu:

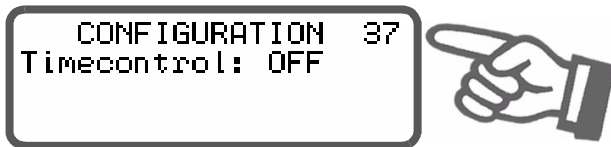

There are two possible settings in this menu:

1. **"OFF" (•)**
Time control (timer) deactivated
2. **"ON with external release imp."**
Time control (timer) is on. If a release impulse is set, it is activated by selecting the external control signal CH1 (terminals 22+4 and 19+2).
3. **"ON with internal release imp."**
Time control (timer) is on. If a release impulse is set, it is controlled by selections in internal menus.

If time control is on, activating the "START" signal starts the internally parameterized timeout. This timeout comprises:

- Starting delay (delay at the beginning of the heating phase)
- Heating phase (heating and control process)

(•) Factory setting

The parameter settings for the subsequent release impulse are described in section 9.15 "Release impulse" on page 43.

The remaining heatsealing time is indicated on the display in the form of a countdown at the end of the heating phase. A direction arrow indicates the active process.

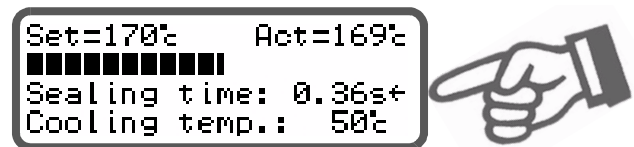

The active cooling phase is subsequently marked with the direction arrow at the end of the heating phase.

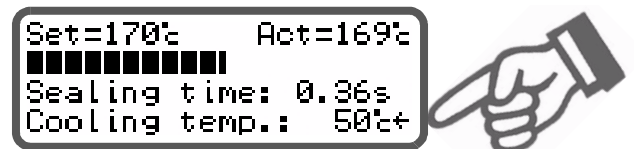

The direction arrow disappears again at the end of the cooling phase (i.e. at the end of the internal timeout).

The current condition of relay K1 is indicated by means of a separate icon. If the icon is visible, the normally open contact of the relay is closed.

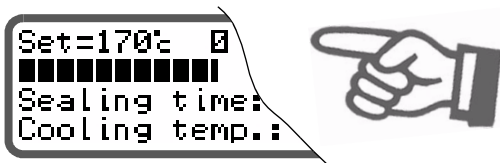

Separate settings can be entered for the individual timeouts. These settings are possible with steps 3 and 4 and steps 34, 38, 39 and 41 in the Configuration menu

The options available with these advanced settings are described below.

9.14.2 Setting the starting delay

The start of the heating process can be explicitly delayed by entering a starting delay time with step 41 in the Configuration menu, e.g. in order to bridge the closing time of the heatsealing bars.

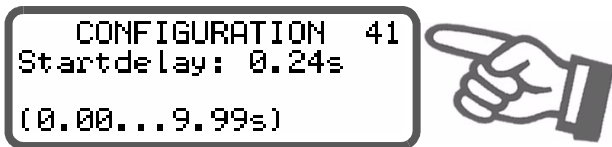

When the "START" signal is activated, the controller waits for the time specified with this menu step to elapse before commencing the heating process.

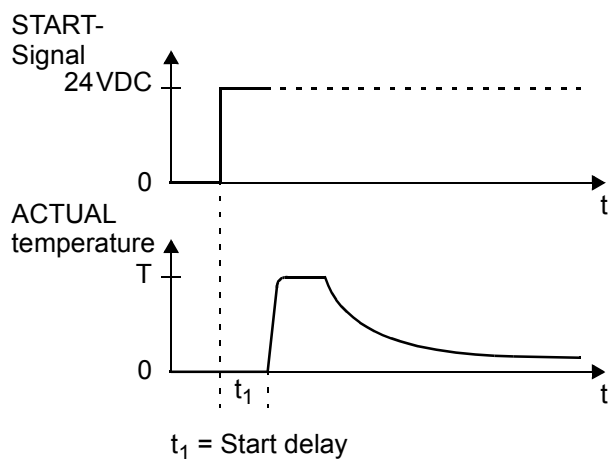

The starting delay can be set in the range from 0 to 9.99s. A delay of 0s is defined as the factory setting. In this case, the heating process begins as soon as the "START" signal is activated.

9.14.3 Setting the heatsealing time

This menu step is used to enter the heatsealing time:

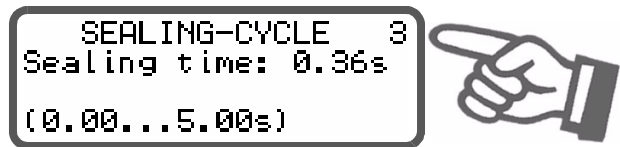

The heatsealing time can be set in the range from 0...5.00s. The factory setting is 0.10s.

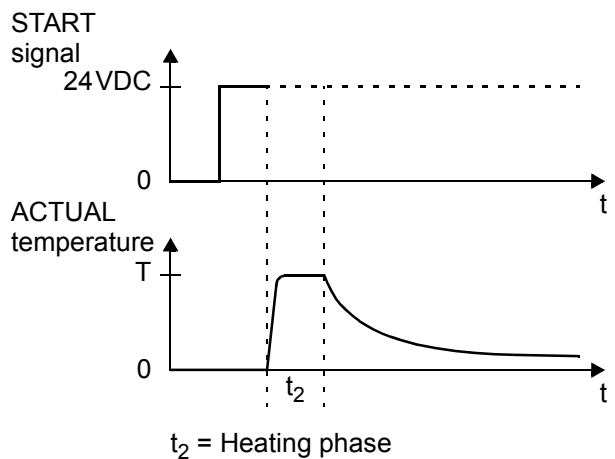

! The setting range is limited to 5.00seconds in order to avoid overheating the UPT heating element.

9.14.4 Setting the cooling mode

Various criteria for the end of the cooling phase can be specified with step 38 in the Configuration menu of the UPT-640 controller:



The possible settings are as follows:

1. **"Absolute" (•)**
The cooling phase ends when the ACTUAL temperature of the heatsealing band falls below a specified temperature value. This cooling temperature can be set with step 4 in the Settings menu.
2. **"Relative"**
The cooling phase ends when the ACTUAL temperature falls to a value corresponding to X% of the

(•) Factory setting

SET temperature. This percentage cooling value can be set with step 4 in the Settings menu.

Example:

SET temperature = 180°C, cooling value = 60%

→ Cooling phase ends when ACTUAL temperature ≤ 108°C

3. "Time"

The cooling phase ends after a specified time in seconds and is independent of the ACTUAL temperature. This cooling time can be set with step 4 in the Settings menu.

The various cooling modes are shown below:

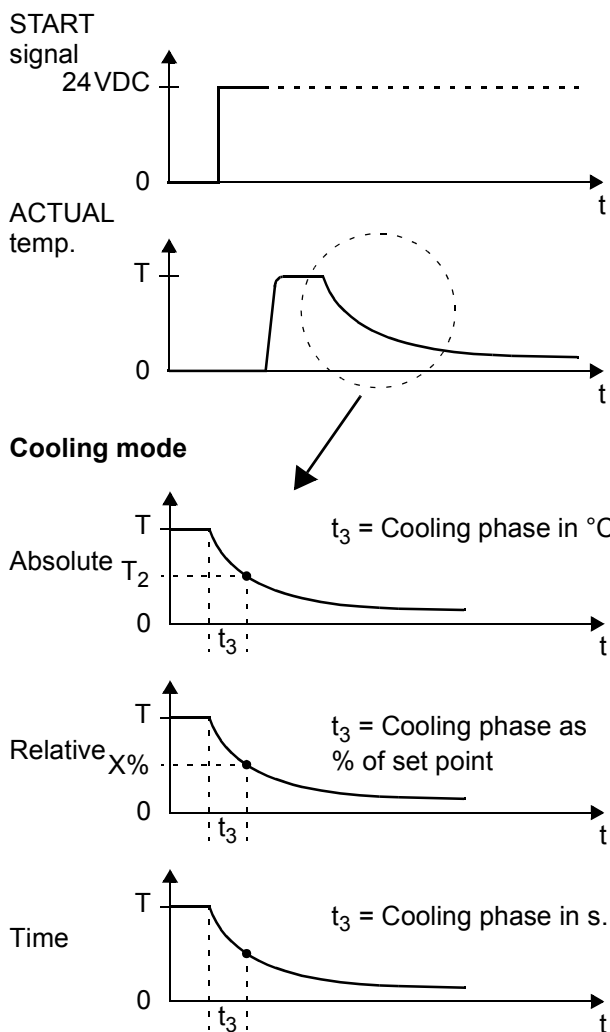

9.14.5 Setting the cooling value

After the cooling phase has been configured with step 38 in the Configuration menu (↪ section 9.14.4 "Setting the cooling mode" on page 41), you can specify the cooling parameters with step 4 in the Settings menu.

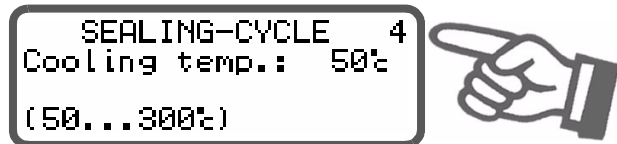

⚠ The options available with step 4 in the Settings menu vary according to the selection made with step 38 in the Configuration menu. All settings entered with step 4 are overwritten if step 38 is changed subsequently.

The possible settings are as follows:

1. "Cooling temp. in °C"

(if setting with step 38 = "Absolute")

The cooling phase of the internal timeout ends when the ACTUAL temperature of the heatsealing band falls below the set temperature.

The minimum settable temperature is 50°C. This is also the factory setting.

⚠ The maximum value of the setting range is limited either by the maximum value specified with step 33 in the Configuration menu or by the heatsealing band type/temperature range set with step 32.

2. "Cooling temp. in %"

(if setting with step 38 = "relative")

The cooling phase of the internal timeout ends when the ACTUAL temperature falls to the specified percentage of the SET temperature. This value can be set between 40 and 100%.

The factory setting is 40%.

3. "Cooling time in s"

(if setting with step 38 = "time")

The cooling phase ends when the specified time elapses. This time can be set between 0 and 9.99s. The factory setting is 1.00s.

9.14.6 Relay K1 (with time control)

The function of relay K1 when time control is active is also specified with step 39 in the Configuration menu (↪ section 8.3.6 "Relay K1 (without time control)" on page 19):



The settings described here are only possible if time control is active. These settings can be selected as follows:

1. **"When start signal present"**
The normally open contact of relay K1 closes as soon as the "START" signal is activated and remains closed until the end of the parameterized timeout (i.e. until the end of the cooling phase).
2. **"When temperature reached"(*)**
The normally open contact of relay K1 closes when the ACTUAL temperature reaches 95% of the SET temperature and remains closed until the end of the parameterized timeout (i.e. until the end of the cooling phase).
3. **"While cooling"**
(Software release 011 and later)
The normally open contact of relay K1 closes at the end of the heating phase and remains closed until the end of the cooling phase.
4. **"End-of-cycle impulse"**
The normally open contact of relay K1 closes at the end of the parameterized timeout (i.e. at the end of the cooling phase) and opens again after approximately 500ms. If a "START" signal is activated while

(*) Factory setting

relay K1 is still closed, the relay opens again immediately.

The possible settings are shown below:

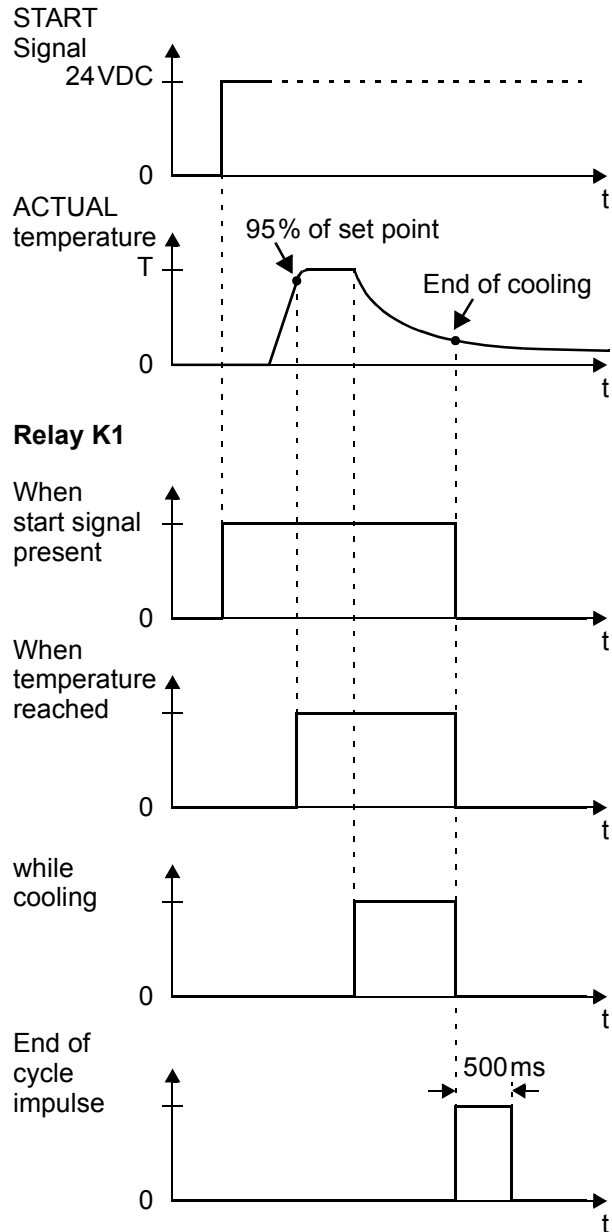

9.15 Release impulse

If a film sticks to the heating element after the heat-sealing process, it can be released by subsequently

applying a short heat impulse and simultaneously tau-tening it.

The principle is shown in the diagram below.

The sealing impulse is applied with the sealing bar and the jaw bars closed

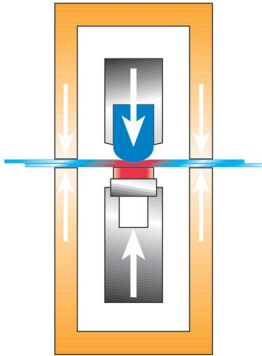

The sealing bar begins to open after the tool has cooled down

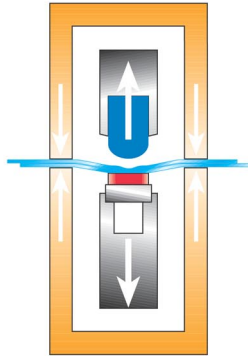

A release impulse is applied when the film is clamped as the sealing bar is withdrawn

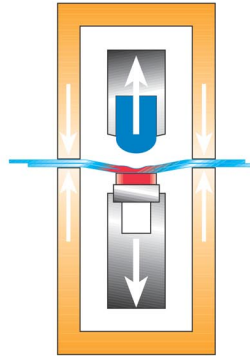

The film is released and the jaw bars are opened

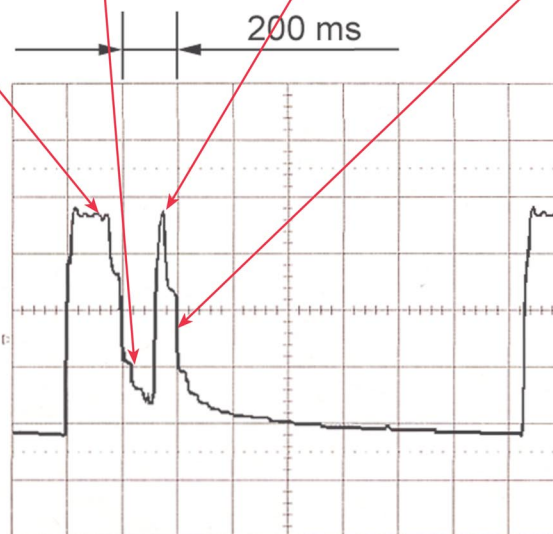
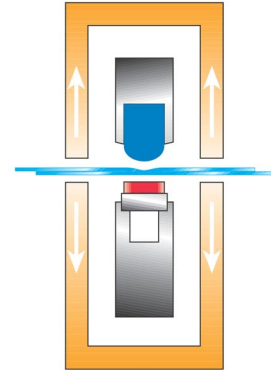

The release impulse can be generated in various ways, to enable it to be applied at exactly the right instant in the heatsealing sequence. The temperature and duration of this impulse can be set individually.

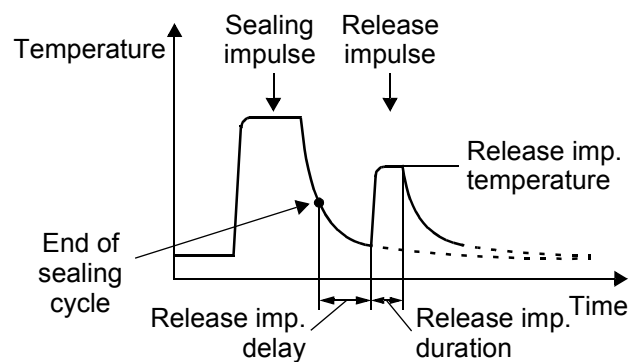

9.15.1 Temperature setting

The temperature of the release impulse can either be set in step 10 or specified by applying an external voltage at the analog input (terminals 23+20).

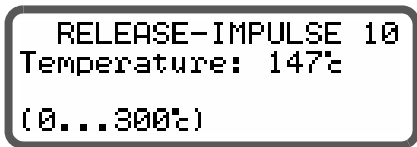

! The release impulse temperature is set in the same way as described for the temperature selection function (set point selection). Please heed the instructions and recommendations contained in section 9.6 "Temperature setting (set point selection)" on page 34!

9.15.2 Impulse generated internally

The timer function must be set to "ON with internal release imp." for this purpose in step 37 (↪ section 9.14 "Time control (timer function)" on page 40).

The timeout for the release impulse then begins immediately after the end of the heatsealing phase (i.e. at the end of the cooling phase). You can also configure a delay (step 11) and a duration (step 12) for the release impulse in addition to the temperature.

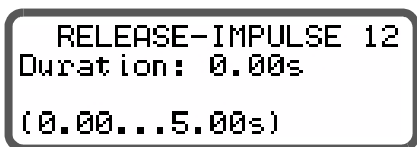
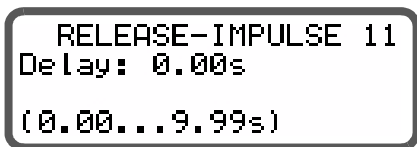

! A release impulse is not generated if the release temperature (step 10) or the impulse duration (step 12) are set to "0".

9.15.3 Impulse generated externally

If this configuration is selected, the release impulse is controlled by activating the external control signal CH1. This signal can be activated in two ways:

- By means of a 24VDC signal at terminals 22+4.

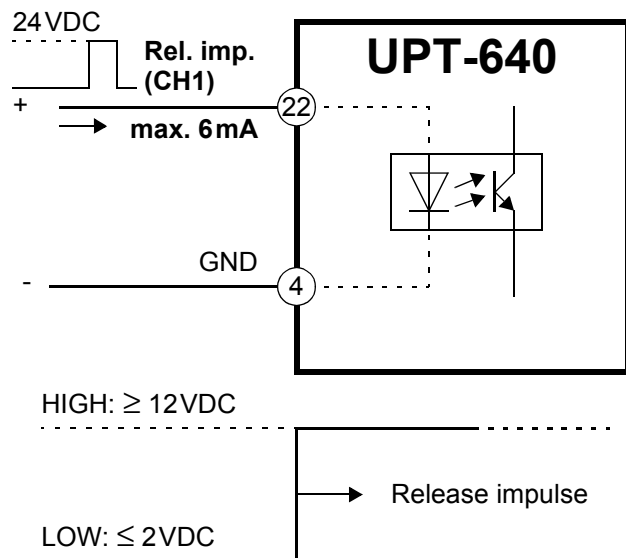

- By means of a control contact at terminals 2+19 (all controllers manufactured as of July 2002).

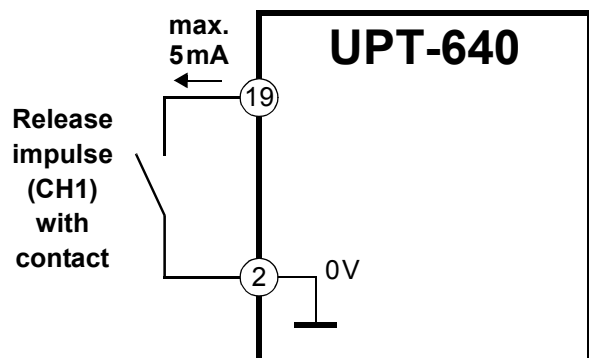

The following functions are possible, depending on the time control setting in step 37 (↪ section 9.14 "Time control (timer function)" on page 40):

1. **If time control is "OFF"**
The delay and the impulse duration cannot be specified internally by the controller. The start and duration of the release impulse are dependent on the activation of the external control signal CH1 (terminals 22+4 and 2+19).
2. **If time control is "ON with external release imp."**
With this setting the delay (step 11) and the duration (step 12) of the release impulse are specified by the

! The maximum impulse duration is limited internally by the controller to 5seconds, in order to avoid damaging the heating element. If this time limit is exceeded, heating is terminated automatically (software Version 011 or higher).

controller.

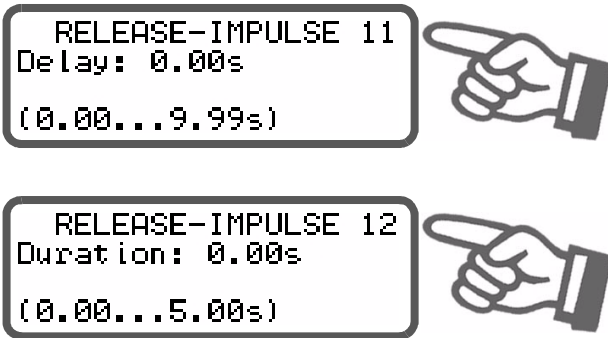

The release impulse (i.e. the delay) starts when the external control signal CH1 is activated.

! A release impulse cannot be started until the end of the heatsealing cycle (i.e. the end of the cooling phase). If the CH1 control signal is activated earlier – or if the temperature and the impulse duration (steps 10 and 12) are set to "0" – a release impulse is not generated.

9.16 Correction factor Co

The correction factor Co permits the UPT-640 controller to be adapted to the real conditions in the machine (type of UPT heating element, impulse transformer specification, length of connecting wires, cooling etc.).

Proceed as follows to determine the optimum correction factor Co (setting in step 6):

1. Controller settings:
 - Set temperature:160...180°C(step 2)
 - Sealing time:0.20...0.30s(step 3)
 - Hold function:2s(step 5)
2. Manual impulses (step 20):
 Proceed as described in section 9.17 "Manual impulse" on page 46.

Slowly increase the correction factor – starting either with the lowest value (50%) or with the value recommended in the ROPEX Application Report minus 25% – to the indicated hold value = set temperature.

The correction factor should be checked, and if necessary corrected, whenever the machine is operated or

the set temperature or the heatsealing time are changed.

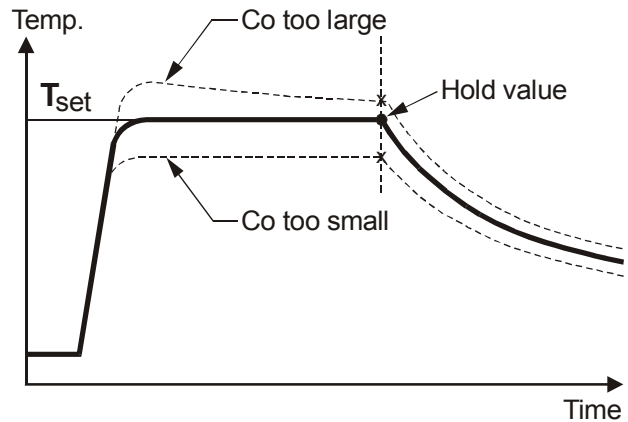

9.17 Manual impulse

Individual heating processes and heatsealing cycles can be started manually (manual impulse), in order to set the correction factor Co and start up the machine or plant. There are two ways to do so:

1. **Automatic heatsealing cycle with step 20**
 (only available if time control is on)

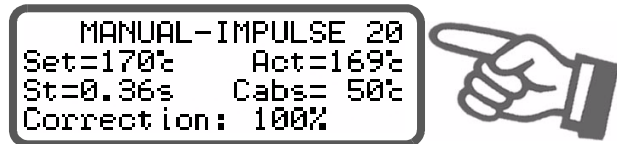

The automatic heatsealing cycle is executed on the basis of the values set with the timer function (↪ section 9.14 "Time control (timer function)" on page 40).

This cycle can be started once only by pressing the "ENTER" key. The correction factor Co can be changed and matched directly in this menu with the cursor "UP" and "DOWN" keys.

The following terms are used in this menu step:

Term	Meaning
Set	Set point
Act	Current actual value
St	Heatsealing time
Cabs	Absolute cooling temperature
Crel	Relative cooling temperature
Ct	Cooling time

2. Manual heating with step 21

```
MANUAL-IMPULSE 21
Set=170% Act=169%
Permanent heating
Correction: 100%
```



The duration of the heating process selected with this menu step is equal to the time for which the "ENTER" key is pressed. The correction factor Co can also be changed and matched directly in this menu with the cursor "UP" and "DOWN" keys.

! The maximum duration of the heating process is limited internally by the controller to 5seconds, in order to avoid damaging the heating element. If this time limit is exceeded, heating is terminated automatically (Software version 011 or higher).

9.18 Maximum starting temperature

You can set the required maximum starting temperature in step 40.

```
CONFIGURATION 40
Max. admissible
start-temp.: 300%
(20...300%)
```



This temperature is the maximum permissible actual value at the start time. The value is determined by the controller at the start of each impulse and compared with the value set in step 40.

This function serves to monitor the cooling circuit.

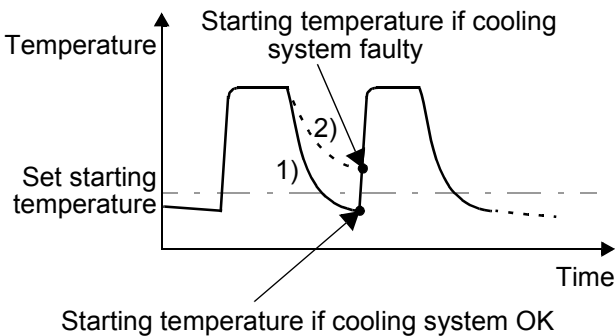

If the cooling system is intact, the tool is cooled down according to curve 1). If the cooling system is faulty, it is cooled down according to curve 2) because the water

is no longer cooled. As a result, the temperature is always at least the value set with this menu step. In this case, the controller ignores the next heating command and reports an alarm. This prevents the UPT sealing bar from being damaged beyond repair.

! The maximum value of the setting range is limited either by the maximum value specified with step 33 in the Configuration menu or by the temperature range set with step 32.

Setting:

We advise you not to set this parameter until you have determined the optimum heatsealing parameters (temperature and cooling time) for productive operation. The starting temperature should be set to approximately 50% of the heatsealing temperature for the trial run, to enable the optimum working parameters to be established correctly.

9.19 Disabling the Configuration menu

(Software version 011 or higher)

It is possible to disable all changes to values/parameters in the Configuration menu. This prevents the controller configuration from being tampered with by unauthorized persons.

The Configuration menu can be disabled or enabled by pressing the "MENU" key for 2.0seconds while the power-up message is displayed (after switching on the controller, see section 9.2.1 "Power-up message" on page 21). The display then shows a message confirming that the disable function is active for 3.0seconds before returning to the home position.

```
*****
*Configuration menu*
*      LOCKED      *
*****
```



The same message is also displayed for 5.0seconds when you open the Configuration menu to indicate that this menu is disabled.

! You can still display all the steps, values and parameters if the Configuration menu is disabled. You are no longer allowed to enter or change values, however.

The Configuration menu remains disabled until the disable function is canceled again. To do so, repeat the above procedure (press the "MENU" key for

2.0seconds while the power-up message is displayed). The display then shows a message confirming that the disable function has been canceled.

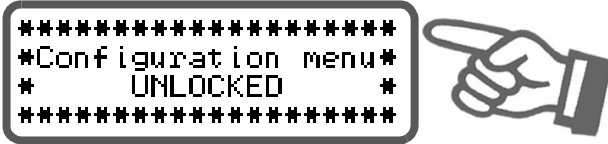

In the factory setting the Configuration menu is not disabled.

9.20 Setting the display brightness (VF display only)

(Software revision 013 or higher)

If the display is in the home position, the brightness of the VF display (blue) can be set in 4 steps (25%, 50%, 75%, 100%) with the "UP" and "DOWN" keys. The factory setting is 75%.

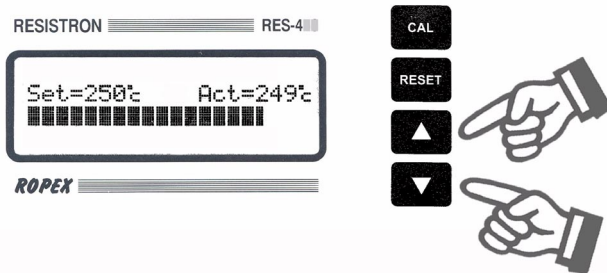

The life of the VF display can be prolonged by reducing the brightness.

9.21 Undervoltage detection

Trouble-free operation of the temperature controller is guaranteed within the line voltage tolerance range specified in section 5 "Technical data" on page 9. If a line voltage which is less than the lower limit of the permissible range occurs, the controller is switched to a standby mode. No more heatsealing processes take place and no more measuring impulses are generated. The display changes to indicate this.

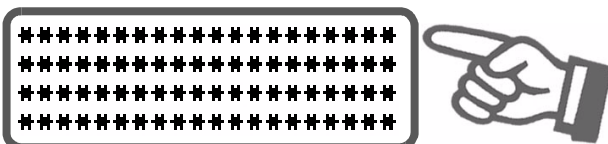

The main menu is displayed again, and operation is resumed, when the input voltage returns to the specified tolerance range.

The alarm relay (terminals 5+6) is only switched by an undervoltage condition in controllers up to and including software revision 008. The last valid temperature value continues to appear at the analog output (terminals 20+24).

The alarm relay in controllers with a higher software revision number is not switched if an undervoltage condition occurs. The standby mode is indicated by 0°C (corresponds to 0V) at the analog output.

! Trouble-free operation of the controller is only guaranteed within the specified input voltage tolerance range. An external voltage monitor must be connected to prevent defective heatseals as a result of low line voltage.

9.22 Booster connection

The UPT-640 controller has a connection for an external switching amplifier (booster) as standard. This connection (at terminals 1+2) is necessary for high primary currents (continuous current > 5A, pulsed current > 25A). The switching amplifier should be connected as described in section 7.7 "Wiring diagram with booster connection" on page 16. No settings are required in the menu.

9.23 System monitoring/alarm output

To increase operating safety and to avoid faulty heatsealing, this controller incorporates special hardware and software features that facilitate selective fault detection and diagnosis. Both the external wiring and the internal system are monitored.

These features crucially support the system owner in localizing the cause of an abnormal operating state.

A system fault is reported or differentiated by means of the following elements.

A.) Error message on the display:

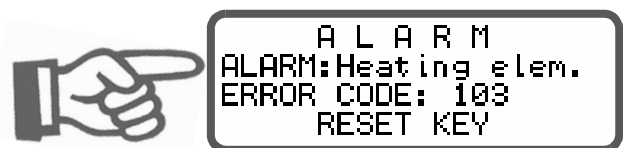

The cause of a fault can be localized quickly and easily with the help of the error code that appears on the display.

play. Please refer to section 9.24 "Error messages" on page 49 for a list of the possible error codes.

B.) Alarm relay (relay contact, terminals 5+6):

This contact is set in the factory as follows:

- **OPEN** if error code 104...106, 111...113 or 211 is displayed. The contact closes, however, if a "START" signal is activated in this state.
- **CLOSED** if error code 101...103, 107, 108, 201...203, 801 or 9xx appears.

If the alarm relay is configured differently from the factory setting (↪ section 8.3.7 "Configuration of the alarm relay" on page 19), these states are inverted.

C.) Error code output via the 0 to 10VDC actual value output (terminals 20+24):

Since a temperature indication is no longer necessary if a fault occurs, the actual value output is used to display error messages in the event of an alarm.

12 voltage levels are offered for this purpose in the 0...10VDC range, each of which is assigned an error code (↪ section 9.24 "Error messages" on page 49).

If a state that requires AUTOCAL occurs – or if the controller configuration is not correct – (error codes 104...106, 111...113 or 211), the actual value output jumps backwards and forwards at 1Hz between the voltage value which corresponds to this error and the end of the scale (10VDC, corresponding to 300°C). If

the "START" signal is activated in one of these states, the voltage value does not change any more.

Selective fault detection and indication can thus be implemented simply and inexpensively using the analog input of a PLC with a corresponding evaluation (↪ section 9.24 "Error messages" on page 49).

! An alarm can be reset by pressing the "RESET" key, by activating the "RESET" signal at terminals 20+26 (↪ section 9.10 "'RESET" signal" on page 38) or by switching the controller off and then on again.

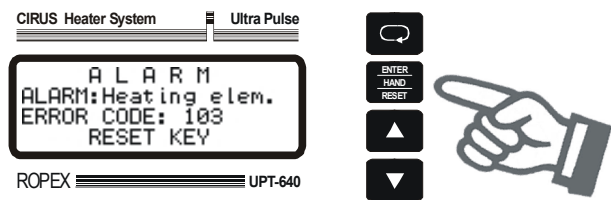

9.24 Error messages

The table below shows how the analog voltage values that appear at the actual value output are assigned to the faults that have occurred. It also describes the fault causes and the action which must be taken to rectify them.

The block diagram in section 9.25 "Fault areas and causes" on page 51 permits each fault to be cleared quickly and efficiently.

Error code	Act. value output; Voltage [V]	Temp. 300 °C [°C]	Temp. 500 °C [°C]	STATUS of alarm relay (factory set.)	Cause	Action if machine started for first time	Action if machine already operating, HS band not chang.
101	0.66	20	33	Closed	I _R signal missing	Fault area ①	Fault area ①
102	1.33	40	66		U _R signal missing	Fault area ③	Fault area ③
103	2.00	60	100		U _R and I _R signals missing	Fault area ②	Fault areas ②③
107 108	2.66	80	133	Closed	Temperature step	Fault areas ④⑤⑥ (loose contact)	Fault areas ④⑤⑥ (loose contact)
201 202 203	3.33	100	166		Frequency fluctuation, inadmissible line frequency	Check power supply	Check power supply
801	4.00	120	200		Internal fault	Run RESET	Run RESET
9xx	4.66	140	233	Open, does not close until "START" signal (voltage value at actual value output then no longer changes)	Internal fault, controller defective	Replace controller	Replace controller
104 105 106	↺5.33 ↻ 10↻	↺160 ↻ 300↻	↺266 ↻ 500↻		U _R and/or I _R signal incorrect	Run AUTOCAL	Fault areas ④⑤⑥
211	↺6.00 ↻ 10↻	↺180 ↻ 300↻	↺300 ↻ 500↻		Data error	Run AUTOCAL	---
111	↺6.66 ↻ 10↻	↺200 ↻ 300↻	↺333 ↻ 500↻	Open, does not close until "START" signal (voltage value at actual value output then no longer changes)	I _R signal incorrect, calibration not possible	Fault area ⑧, check configuration	---
112	↺7.33 ↻ 10↻	↺220 ↻ 300↻	↺365 ↻ 500↻		U _R signal incorrect, calibration not possible	Fault area ⑦, check configuration	---
113	↺8.00 ↻ 10↻	↺240 ↻ 300↻	↺400 ↻ 500↻		U _R and I _R signals incorrect, calibration not possible	Fault area ⑦⑧, check configuration	---

9.25 Fault areas and causes

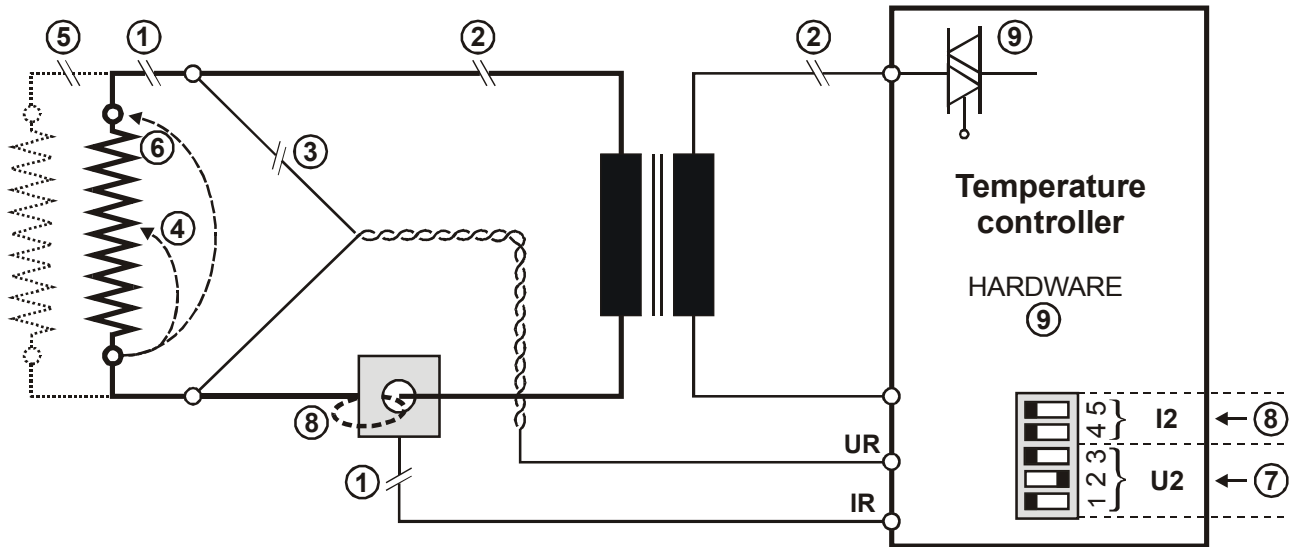

The table below explains the possible fault causes.

Fault area	Explanation	Possible causes
①	Load circuit interrupted after U_R pickoff point	- Wire break, heating element break - Contacting to heating element defective
	PEX-W2 current transformer signal interrupted	- I_R measuring wire from current transformer interrupted
②	Primary circuit interrupted	- Wire break, triac in controller defective - Primary winding of impulse transformer interrupted
	Secondary circuit interrupted before U_R pickoff point	- Wire break - Secondary winding of impulse transformer interrupted
③	U_R signal missing	- Measuring wire interrupted
④	Partial short-circuit (ΔR)	- Heating element partially bypassed by conducting part (clamp, opposite heatsealing bar etc.)
⑤	Parallel circuit interrupted	- Wire break, heatsealing band break - Contacting to heating element defective
⑥	Total short-circuit	- Heating element installed incorrectly, insulation at heatsealing bar ends missing or incorrectly installed - Conducting part bypasses heating element completely
⑦	U_R signal incorrect	- DIP switches 1 - 3 configured incorrectly (U_2 range)
⑧	I_R signal incorrect	- DIP switches 4 + 5 configured incorrectly (I_2 range)
	Turns through PEX-W2 current transformer incorrect	- Check number of turns (two or more turns required for currents < 30A)
⑨	Internal controller fault	- Hardware fault (replace controller)

10 Factory settings

The CIRUS temperature controller UPT-640 is configured in the factory as follows:

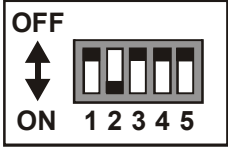
<p><u>DIP switches</u> for secondary voltage U_2 and current I_2</p>		<p>$U_2 = 6...60VAC$ $I_2 = 30...100A$</p> <p>DIP switches: 2 ON 1, 3, 4, 5 OFF</p>
<p><u>Values in the Settings and Configuration menus</u></p>	<p>Settings menu</p> <p>No. 1 AUTOCAL temperature: 20°C No. 2 Heatsealing temperature: 0°C No. 3 Heatsealing time: 0.10s No. 4 Cooling value: Cooling time: 1.00 s Absolute cooling temperature: 50°C Relative cooling temperature: 40 % of heat-sealing temperature</p> <p>No. 5 Hold mode: OFF No. 6 Correction factor 100%</p> <p>Release impulse</p> <p>No. 10 Temperature: 0°C No. 11 Delay: 2.00s No. 12 Duration: 0.00s</p> <p>Configuration menu</p> <p>No. 30 Language: German This selection is NOT changed if the factory settings are restored with step 31 in the Configuration menu.</p> <p>No. 32 Alloy/range: TCR 1700ppm, max. 300°C No. 33 Maximum temperature: 300°C No. 34 Analog output: Actual temperature No. 35 Set point reached: -10K No. 36 Set point exceeded: +10K No. 37 Time control: OFF No. 38 Cooling mode: Absolute No. 39 Relay K1 function: Active when temperature reached No. 40 Start temperature: 100°C No. 41 Start delay: 0.00s No. 42 Cycle counter: 0 No. 43 Alarm relay: Normal (contact closed by alarm)</p>	

The controller can be reset with step 31 in the Configuration menu:

```

CONFIGURATION 31
For factory settings
press ENTER!
    
```



The factory settings are restored if the "ENTER" key is pressed. An acknowledgment message is displayed for approximately 2s.

```
CONFIGURATION 31
Factory settings are
recalled!
```









 **The language which is selected with step 20 in the Configuration menu remains set even if the factory settings are restored.**

11 Maintenance

The controller requires no special maintenance. Regular inspection and/or tightening of the terminals – including the terminals for the winding connections on

the impulse transformer – is recommended. Dust deposits on the controller can be removed with dry compressed air.

12 How to order

	<p>Contr. UPT-640- . / . . . VAC</p> <ul style="list-style-type: none"> L / 230: LC-Display, line voltage 230VAC, Art.-No. 664012 L / 400: LC-Display, line voltage 400VAC, Art. No. 664013 V / 230: VF-Display, line voltage 230VAC, Art. No. 664022 V / 400: VF-Display, line voltage 400VAC, Art. No. 664023 <p>Scope of supply: Controller includes connector plug-in parts (current transformer must be ordered separately)</p>
	<p>Current transformer PEX-W2 Art. No. 885104</p>
	<p>Line filter LF- . . . 480</p> <ul style="list-style-type: none"> 06: Continuous current 6A, 480VAC, Art. No. 885500 35: Continuous current 35A, 480VAC, Art. No. 885506
	<p>Impulse transformer ITR-x See ROPEX Application Report for design and ordering information</p>
	<p>Temp. meter ATR- 3 300°C range, Art. No. 882130</p>
	<p>Booster B- . . . 400</p> <ul style="list-style-type: none"> 075: Max. pulse load 75A, 400VAC, Art. No. 885301 100: Max. pulse load 100A, 400VAC, Art. No. 885304

13 Index

A

Actual value output 35
Adapter for top hat rail mounting 7
Alarm output 48
Alarm relay 9, 19, 34
Alarm signals 22
Alloy 18, 31
Ambient temperature 9
Analog output 31
Analog temperature meter 6
Application 4
Application Report 12, 14, 18
AUOTCAL 28
AUTOCAL 20, 36
Automatic zero calibration 20, 28, 36

B

Booster 6, 7, 54
Booster connection 48

C

Circuit breaker 13
Configuration 17, 31
Configuration menu 22
Cooling mode 32, 41
Cooling temperature 42
Cooling time 42
Cooling value 29, 42
Correction factor 29, 46
Current transformer 3, 6, 14, 54
Cycle counter 33, 39

D

Degree of protection 9
Digital temperature meter 6
Dimensions 11
DIP switches 17, 18, 52
Disabling the config. menu 47
Display 21
Display brightness 48
Door, lockable 7

E

Error messages 49

F

Factory settings 18, 52
Fault areas 51
Front cover 7

H

HEAT 20, 37
Heating element 3, 4, 9

Heatsealing temperature 28
Heatsealing time 29
Hold mode 39
Holde mode 29
Home position 22, 28
Housing material 10
How to order 54

I

Impulse transformer 3, 7, 13, 54
Installation 10, 12

L

Language 18, 31
Line filter 3, 7, 13, 14, 54
Line frequency 9
Line voltage 9

M

Maintenance 53
Manual Impulse 31, 46
Manual mode 34
Measurement cable 7
Menu steps 28
Menu structure 26
MOD 8
Modification 8

N

Navigation in the menus 23

P

PEX-W2 3, 6, 14, 54
Potentiometer 7
Power supply 13
Power-up message 21

R

Reference voltage 36
Relay K1 9, 19, 33, 43
Release Impulse 30, 43
"RESET" signal 38

S

Secondary current I_2 18
Secondary voltage U_2 18
Set point potentiometer 7
Set point selection 9, 34
Settings menu 22
Standby mode 48
"START" signal 20, 37
Starting delay 33, 41

Starting temperature 33, 47
Startup 17, 19
System monitoring 48

T

Temperature indication 35
Temperature meter 6, 35, 54
Temperature OK 9, 38
Temperature range 9, 18
Temperature setting 34
Time control 18, 32, 37, 40
Timer function 18, 32, 37, 40
Transformer 3, 7, 13, 54

Type of construction 9

U

Undervoltage detection 48

V

View of the controller 17

W

Weight 10
Wiring 12, 13
Wiring diagram 15, 16